

PC1575 System Introduction

S E C T I O N 1

1.1 Specifications

Control Panel Specifications

PC1575 (standard option): one low current PGM output and one low current PGM output/input.

PC1575 (2-wire smoke option): one low current PGM output and one high current PGM output/input.

Flexible Zone Configuration:

- Six fully programmable zones
- Seven Access Codes: five User, one Master and a second Master code
- Normally Closed, Single EOL, Double EOL
- 2-wire Smoke Zone or Auxiliary Zone
- 21 Zone Types, 6 Programmable Zone Options

Audible Alarm Output:

- Supervised Bell Output (current limited at 3 amps), 12Vdc
- Steady or Pulsed Output

EEPROM Memory:

- Does not lose programming or system status on complete AC and Battery failure

Programmable Outputs:

- One programmable voltage output and one programmable voltage output/input; 30 programmable options
- **PC1575 (standard option):**
PGM1 = one low current (50mA) PGM output
PGM2 = one low current (50mA) PGM output/input.
- **PC1575 (2-wire smoke option):**
PGM1 = one low current (50mA) PGM output
PGM2 = one high current (300mA) PGM output/input with 2-wire smoke detector capability



Please read Appendix D "PGM Output Options" carefully for important information.

Powerful 1 Amp Regulated Power Supply:

- 550 mA Auxiliary Supply, 12 Vdc
- Positive Temperature Coefficient (PTC) components replace fuses
- Supervision for loss of AC Power, Low Battery
- Internal Clock Locked to AC Power Frequency

Power Requirements:

- Transformer = 16.5 VAC, 40VA
- Battery = 12 volt 4 Ah minimum rechargeable sealed lead acid

Remote Keypad Specifications:

- Three Different Keypads Available:
 - PC5506 six zone LED keypad
 - LCD5500 Alphanumeric keypad
 - PC1575RK six zone LED keypad
 - SL-75 six zone LED keypad
- The PC5506 and LCD5500 keypads have 5 Fully Programmable Function Keys
- Connect up to 8 Keypads
- Four Wire (Quad) Connection to KEYBUS
- Built in Piezoelectric Buzzer

Digital Communicator Specifications:

- Supports Major Formats including SIA and Contact ID
- Event Initiated Personal Paging
- Three Programmable Phone Numbers
- Two Account numbers
- Supports LINKS 1000 Cellular Communication
- DTMF and Pulse Dialing
- DPDT Line Seizure
- Anti-jam Feature
- Split Reporting of Selected Transmissions to Each Telephone Number

System Supervision Features:

The PC1575 continuously monitors a number of possible trouble conditions including:

- AC Power Failure
- Trouble by Zone
- Tamper by Zone
- Fire Trouble
- Telephone Line Trouble
- Failure to Communicate
- Low Battery Condition
- Bell Output Trouble
- Module Fault (Supervisory or Loss of Internal Clock AUX Power Supply Fault Tamper)

False Alarm Prevention Features:

- Audible Exit Delay
- Audible Exit Fault
- Communication Delay
- Urgency on Entry Delay
- Quick Exit

Additional Features:

- Auto Arm at Specified Time
- Keypad Activated Alarm Output and Communicator Test
- All modules connect to the system via a four wire KEYBUS up to 1000'/300m from main panel
- Event Buffer can be printed using PC5400 RS232 Serial Interface module
- Supports the ESCORT 5580 Voice Prompt Module with Automation/Lighting Control
- An Event Buffer which records the past 100 events with both the time and date at which they occurred
- Uploading and Downloading capability
- Local Downloading capability through the use of the PC-LINK Adaptor

UL Installation

This equipment is UL Listed in accordance with UL1023 (Household Burglar Alarm System Units), UL985 (Household Fire Warning System Units), UL1635 (Digital Alarm Annunciator System Units), UL365 (Police Station Connected Burglar Alarm Units and Systems), UL609 (Local Burglar Alarm Units and Systems), UL1610 (Central Station Burglar Alarm Units). This equipment has the capability of being programmed for operational features that are not allowed for UL Listed Systems or being connected to accessories not permitted. **Refer to Appendix E for summary of requirements.**

1.2 Additional Devices

1.2.1 Keypads

A maximum of eight keypads can be connected to the control panel and can be any combination of the following listed.

- **PC5506** 6 zone LED keypad with function keys
- **LCD5500** LCD keypad with function keys
- **PC1575RK** 6 zone LED keypad
- **SL-75** 6 zone Slimline LED keypad

1.2.2 ESCORT5580 Module

There are many benefits to adding the ESCORT5580 module to a security system. The ESCORT5580 module will turn any touch tone phone in the world into a fully functional keypad. Imagine the security a customer would feel if they had the ability to arm, disarm and check status of their alarm system while at the office or on vacation.

All touch tone phones in the home also become system keypads. For example, at bedtime, the phone beside the bed can be used to arm the system. The addition of the ESCORT5580 may reduce the cost of the overall installation, eliminating the need for additional keypads and the labour of running wires.

The ESCORT5580 will also act as a tutor for the system. By using clear, easy to understand sentences, the voice module helps guide the user through functions they may otherwise find difficult to navigate. Programmable zone labels (up to 6 words each from our library of over 240 words) makes the system even easier to use.

The module also has a built-in power line control interface and can control up to 32 power line control devices for lighting and temperature control, giving you the power to add home automation in a very cost effective manner. Devices can be activated individually, as a group, by schedule or can be activated when an event occurs on the system, such as an alarm.

These are just a few of the applications available with the addition of the ESCORT5580 module. For more information, please refer to the ESCORT5580 Installation Manual.

1.2.3 PC5400 Printer Module

This module will give you the added advantage for the commercial customers who like the idea of a permanent record of openings and closing but are put off by the additional monthly monitoring charge. In addition, as reports are generated in real-time, the customer will not have to wait for a monthly report from the monitoring station.

The PC5400 Printer Module will allow the panel to print out all events that occur on the system to any serial printer. The printout will contain the time, date and the event that occurred (see Section – 5.24 "On-site Printer").

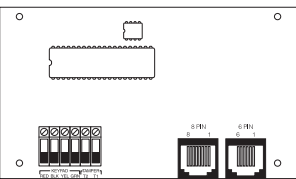
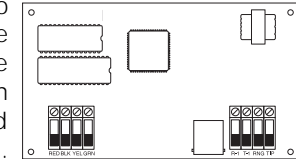

1.2.4 Downlook Video Transmission Module

The Downlook Still-Frame Video Transmission Module (DLM-1/DLM-4) is the ideal solution for all business and residential environments which require visual surveillance but where the presence of on-site security personnel is impossible, undesirable or unaffordable.

Downlook is the smart and inexpensive way to add visual backup to your regular remote alarm signalling system, meeting your demand for tighter security on a tight budget. The added visual protection will reduce the incidence of false alarms as well as surveillance costs, thus improving overall security protection.

For more information regarding the Downlook Video Transmission Module, please consult the DLM-1/DLM-4 Installation Manuals.

1.2.5 LINKS 1000 Cellular Communicator

The LINKS 1000 Cellular Communicator provides an efficient, cost-effective method for adding cellular back up to the security system. The LINKS 1000 Cellular Communicator can be used three different ways: as the sole communicator for the panel, as a back up for either or both phone numbers or as a redundant back up to the land line communicator where the panel will call both the land line and via the LINKS. The unit comes in its own cabinet with antenna and requires a separate battery and transformer (see Section 5.23 "LINKS 1000 Cellular Communicator").

1.2.6 Cabinets

Several different cabinets are available for the PC1575 modules. They are as follows:

PC5003C Cabinet

Main control cabinet for the PC1575 main panel. Dimensions 288mm x 298mm x 78mm / 11.3" x 11.7" x 3" approximately.

PC5004C Cabinet

Cabinet to house the PC5580 ESCORT Module or the PC5400 Printer Module. Dimensions 229mm x 178mm x 65mm / 9" x 7" x 2.6" approximately.

1.3 Out of the Box

Please verify that each of the following components is included in your system:

- one PC1575 main control cabinet
- one PC1575 main control circuit board
- one PC1575 keypad (LED keypad or LCD keypad)
- one Installation Manual including Programming Worksheets
- one Instruction Manual for the end user
- one hardware pack consisting of:
 - four plastic circuit board standoffs
 - twelve 5600Ω (5.6K) resistors
 - one 2200Ω (2.2K) resistors
 - one 1000Ω (1K) resistor
 - EGND Assembly
 - one cabinet door plug

Getting Started

S E C T I O N 2

The following Sections provide a thorough description of how to wire and configure devices and zones.

2.1 Installation Steps

The following steps are provided to assist you with installing the panel. We suggest that you read this section completely before you begin. Once you have an overall understanding of the installation process, carefully work through each step. Working in this manner will reduce the number of problems as well as the amount of time required for a complete installation.

Step 1 Create a Layout

Draw a rough sketch of the building to get an idea of where all alarm detection devices, keypads and other modules are to be located.

Step 2 Mounting the Panel

Locate the panel in a dry area close to an unswitched AC power source and the incoming telephone line. Before attaching the cabinet to the wall, be sure to press the four circuit board mounting studs into the cabinet from the back. After you have attached the cabinet to the wall, stick the provided DSC logo sticker on the front of the cabinet.

! *You must complete all wiring before applying AC or connecting the battery to the panel.*

Step 3 Wiring the KEYBUS (Section 2.3)

Wire the KEYBUS to each of the modules following the guidelines provided in Section 2.3 of this manual.

Step 4 Zone Wiring (Section 2.8)

You must power down the control panel to complete all zone wiring. Please refer to Section 2.8 when connecting zones using normally closed loops, single EOL resistors, double EOL resistors, Fire zones and Keyswitch Arming zones.

Step 5 Complete Wiring (Section 2.2)

Complete all other wiring including bells or sirens, phone line connections, and ground connections following the guidelines provided in Section 2.2 ("Terminal Descriptions").

Step 6 Power up the Control

Once all zone and KEYBUS wiring is complete, power up the control panel.

! *The panel will not power up on the battery connection alone.*

Step 7 Keypad Assignment (Section 2.5)

In order for keypads to be properly supervised, each must be assigned to a different slot. Please follow the guidelines provided in Section 2.5 when assigning keypads.

Step 8 Supervision (Section 2.6)

The supervision of every module by the panel is automatically enabled upon power up. Please verify that all modules appear on the system according to the instructions in Section 2.6.

Step 9 Programming the System (Sections 4 and 5)

Section 4 explains how to program the panel. Section 5 contains a complete description of the various

programmable features, which options are available and how they function. The Programming Worksheets (pages 25-33) should be filled out completely before attempting to program the system.

Step 10 Testing the System

The panel must be thoroughly tested to ensure that all features and functions are operating as programmed.

2.2 Terminal Descriptions

AC Terminals – AC

The panel requires a 16.5 volt, 40 VA transformer. Connect the transformer to an unswitched AC source and connect the transformer to these terminals.

! *Do not connect the transformer until all other wiring is complete.*

Battery Connection

A 12V 4Ah rechargeable gel-cell battery is used as a back up source of power in the event of an AC power failure. The battery also provides additional current when the panel's demands exceed the power output of the transformer, such as when the panel is in alarm.

! *Do not connect the battery until all other wiring is complete.*

Connect the RED battery lead to the positive battery terminal; connect the BLACK lead to negative.

Auxiliary Power Terminals – AUX+ and AUX-

These terminals provide up to 500mA of additional current at 12 Vdc for devices requiring power. Connect the positive side of any device requiring power to the AUX+ terminal, the negative side to AUX- (ground). The AUX output is protected. This means that if too much current is drawn from these terminals (such as a wiring short), the panel will temporarily shut off the output until the problem is corrected.

Bell Output Terminals – BELL+ and BELL- (Section 3.4)

These terminals provide up to 700 mA of continuous current at 12 Vdc for powering bells, sirens, strobes or other warning-type equipment. Connect the positive side of any alarm warning device to BELL+, the negative side to BELL-. Please note that the Bell output is protected: if too much current is drawn from these terminals (such as a wiring short), the Bell fuse will open. Three Amps can be drawn for short periods only.

The Bell output is supervised. If no alarm warning devices are in use, connect a 1000Ω resistor across BELL+ and BELL- to prevent the panel from displaying a trouble condition. For more information, please refer to Section 3.4 ("[*] [2] Trouble Display").

The bell is programmed by default to terminate after four minutes. The **Bell Cutoff** time can be adjusted in programming section [02] ("System Times").

KEYBUS Terminals – AUX+, AUX-, YEL, GRN (Section 2.3)

The KEYBUS is used by the panel to communicate with modules and vice versa. Each module has four KEYBUS terminals that must be connected to the four KEYBUS terminals on the panel. For more information, see [Section 2.3 \("KEYBUS Operation and Wiring"\)](#).

Programmable Output Terminals – PGM1 and PGM2

Please refer to *Appendix D "PGM Output Options"* for output hookup and descriptions.

Zone Input Terminals – Z1 to Z6

Each detection device must be connected to a zone on the control panel. We suggest that one detection device be connected to each zone; wiring multiple detection devices to a single zone, however, is possible. For zone wiring specifics, please see *Section 2.8 ("Zone Wiring")*.

Telephone Connection Terminals – TIP, RING, T-1, R-1

If a telephone line is required for central station communication or downloading, connect an RJ-31X telephone jack in the following manner:

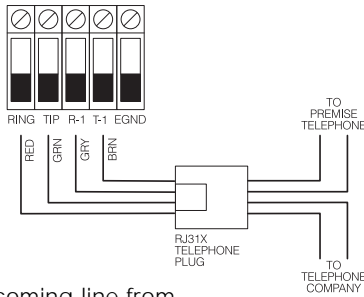

- TIP - Green Wire } incoming line from telephone company
- RING - Red Wire }
- T-1 - Grey Wire } outgoing line to house telephone(s)
- R-1 - Brown Wire }

! Please ensure that all plugs and jacks meet the dimension, tolerance and metallic plating requirements of 47 C.F.R. Part 68, SubPart F. For proper operation, no other telephone equipment should be connected between the control panel and the telephone company facilities. Do not connect the alarm panel communicator to telephone lines intended for use with a fax machine. These lines may incorporate a voice filter which disconnects the line if anything other than fax signals are detected, resulting in incomplete transmissions.

2.3 KEYBUS Operation and Wiring

The KEYBUS is used by the panel to communicate with all connected modules and vice versa. The red (AUX+) and black (AUX-) terminals are used to provide power, while the yellow (YEL) and green (GRN) terminals are clock and data respectively.

! The four KEYBUS terminals of the panel must be connected to the four KEYBUS terminals or wires of all modules.

The following restrictions apply to KEYBUS wiring:

- KEYBUS should be run in minimum 22 gauge quad (0.5mm); two pair twist is preferred.
- The modules should be home-run to the panel but can be connected in series or T-tapped.
- Any module can be connected anywhere along the KEYBUS. You do not need to run a separate KEYBUS wire for keypads, etc.
- No module can be more than 1,000'/300m (in wire length) from the panel.
- Shielded wire should not be used unless wires are run in an area that presents excessive RF noise or other such interference.

Example of KEYBUS Wiring. NOTE:

Module (A) is correctly wired within 1,000'/330m of wire from the panel.

Module (B) is correctly wired within 1,000'/330m of wire from the panel.

Module (C) is NOT wired correctly as it is further than 1,000'/330m from the panel, in wire distance.

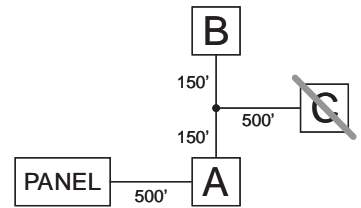

2.4 Current Ratings – Modules and Accessories

In order for the PC1575 system to operate properly, the power output capabilities of the main control and the expansion devices must not be exceeded. Use the data presented below to ensure that no part of the system is overloaded and cannot function properly.

PC1575 (12 Vdc)

VAUX: 500mA. Includes one keypad. Subtract for each additional keypad, expansion module and accessory connected to VAUX or KEYBUS.

BELL: 700 mA. Continuous Rating. 3.0 A. Short Term. Available only with stand-by battery connected.

PC1575 Device Ratings (@ 12 Vdc)

- LCD5500 Keypad: 50 mA
- PC5400 Serial Module: 65 mA
- PC5506 Keypad: 45 mA
- PC1575RK Keypad: 50 mA
- DLM-4: 160 mA standby / 180 mA on-line
- Escort: 65mA standby / 130 mA on-line

Other Devices

Please read the manufacturer's literature carefully to determine the maximum current requirements for each device—during activation or alarm—and include the proper values for loading calculations. Connected devices must not exceed system capabilities during any possible operational mode.

2.5 Keypad Assignment

There are eight available slots for keypads. LED keypads by default are always assigned to slot 1; the LCD5500 is always assigned to slot 8. Whereas the PC1575 LED keypad must always be assigned to slot 1, the PC5506 and LCD5500 keypads can each be assigned to a different slot (1 to 8). Keypad enrollment is required since the panel must know which slots are occupied in order to generate a fault when a supervisory is not present.

How to Assign Keypads

! Each keypad must be assigned one at a time. After assigning all keypads, a supervisory reset should be performed.

To assign a keypad to a slot, enter the following:

1. Enter Installer Programming
 2. Press [00] for Keypad Programming
 3. Press [0] for Slot Assignment
 4. Enter a two digit number (11-18) to specify which supervisory slot the keypad will occupy.
- Press the [#] key twice to exit programming. Continue this procedure at each keypad until they have all been assigned to the correct slot.

! When using more than one LCD keypad, be sure that only one is assigned to slot number 8.

2.6 Supervision

By default, all modules are supervised upon installation. Supervision is enabled at all times so that the panel can indicate a trouble if a module is removed from the system. A connected module which does not show as being present will appear as a trouble condition and the Trouble light on the keypad will turn ON. This condition may be due to one or more of the following reasons:

- the module is not connected to the KEYBUS
- there is a KEYBUS wiring problem
- the module is more than 1,000'/300m from the panel
- the module does not have enough power

For more information regarding module supervision troubles, please refer to **Section 3.4 (*[*] [2] Trouble Conditions*)**.

! Modules will not be automatically supervised if connected while in installers mode.

2.7 Removing Modules

The panel must be instructed to no longer supervise a module being removed from the system. To remove the module, disconnect it from the KEYBUS and reset the supervision field by entering [92] in the installer's programming. The panel will be reset to recognize and supervise all existing modules on the system.

2.8 Zone Wiring

For a complete description of the operation of all zone types, please refer to **Section 5.2 (*Zone Definitions*)**.

There are several different ways in which zones may be wired, depending on which programming options have been selected. Please refer to the following diagrams to study each type of individually supervised zone wiring.

! Any zone defined as Fire or 24 Hour Links Supervisory will automatically require a single End of Line (EOL) resistor regardless of which type of zone wiring supervision is selected. (See Section 5.2 "Zone Definitions") Reconfiguring the zone supervision from a non-default setting—from DEOL to EOL or from NC to DEOL—may disable zones 1-6 while open or in trouble. To prevent this situation, the system should be powered down completely and powered up again.

2.8.1 Normally Closed (NC) Loops

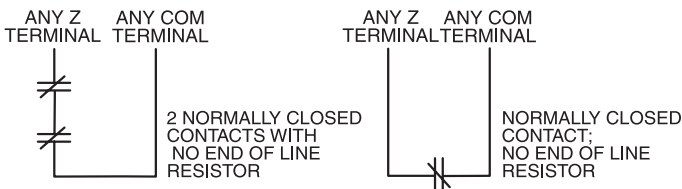

! This option should only be selected if Normally Closed (NC) detection devices or contacts are being used.

2.8.2 Single End Of Line (EOL) Resistors (5600Ω)

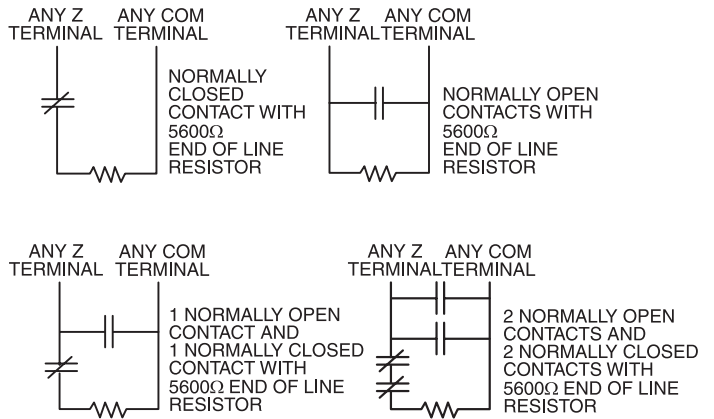

! This option should be selected if either Normally Closed (NC) or Normally Open (NO) detection devices or contacts are being used.

2.8.3 Double End of Line (DEOL) Resistors

Double End of Line resistors allow the panel to determine if the zone is in alarm, tampered or faulted.

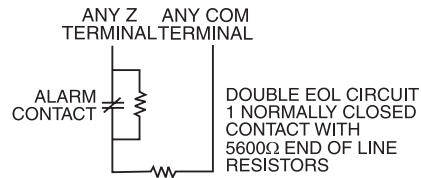

! This option can only be selected if Normally Closed (NC) detection devices or contacts are being used (ie: Do not use DEOL resistors for Fire zones or LINKS Supervisory zones). Only one NC contact can be connected to each zone. Multiple detection devices or contacts on a single loop is not allowed.

The following chart shows zone status under certain conditions:

- Loop Resistance Loop Status
- 0Ω (shorted wire, loop shorted) Fault
- 5600Ω (contact closed) Secure
- Infinite (broken wire, loop open) Tamper
- 11200Ω (contact open) Violated

2.8.4 Fire Zone Wiring — 4-Wire Smoke Detectors

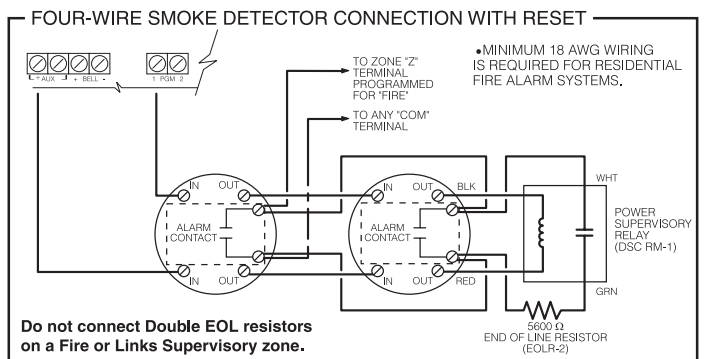

All fire zones must be wired according to the following diagram:

2.8.5 Fire Zone Wiring – 2-Wire Smoke Detectors

This option is for PC1575 (2-wire smoke option) only. If PGM2 has been programmed for a 2-wire Smoke Detector connection, the detectors must be wired according to the following diagram:

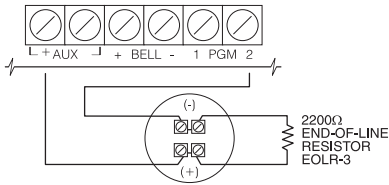

! *2-wire smoke is only available for PC1575 with the 2-wire smoke option because it has a 300mA PGM2. Please refer to Appendix D “PGM Output Options” to verify whether you have the correct output type. If a PC1575 (2-wire smoke option) 300mA PGM2 is programmed for 2-wire smoke support, the connector CON1 on the main board must be removed.*

2.8.6 Keyswitch Zone Wiring (PGM2)

This option is available for either of either a PC1575 (standard option) or PC1575 (2-wire smoke option). If PGM2 has been programmed for keyswitch operation (momentary or maintained) or 24 hour operation, the keyswitches must be wired according to the following diagram:

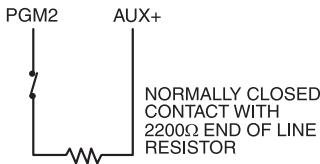

2.8.7 LINKS Support

When using the LINKS 1000 cellular communicator, the connection must be made according to the accompanying diagram.

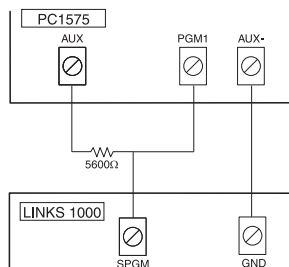

2.8.8 LINKS Supervisory

When using the LINKS 1000 cellular communicator, any zone may be configured for LINKS Supervisory.

With a LINKS Supervisory zone, if the LINKS 1000 experiences a trouble, the zone will be violated, causing the panel to report the event to the central station. This type of zone *always* requires a single EOL resistor (5600Ω).

The LINKS Supervisory zone must be wired according to the accompanying diagram.

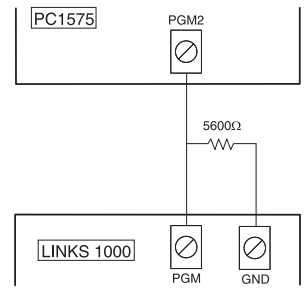

2.8.9 LINKS Answer

When using the LINKS 1000 cellular communicator, PGM2 of either a PC1575 (standard option) or PC1575 (2-wire smoke option) may be configured for LINKS Answer (see Appendix D).

A PGM configured for LINKS Answer allows downloading to be performed in the event of phone line failure. When the LINKS receives a phone call, it will activate the RING terminal on the LINKS circuit board. The PGM programmed as LINKS Answer *always* requires a single EOL resistor (2200Ω).

The LINKS Answer zone must be wired according to the accompanying diagram.

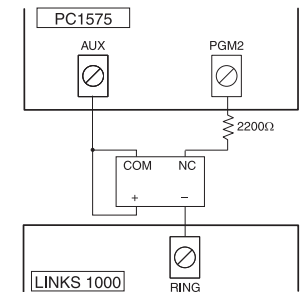

- !** *The LINKS Answer zone is only required for downloading to the panel via the LINKS.*
- !** *If PGM2 is programmed for LINKS Answer, Jumper CON1 on the main board of a PC1575 (2-wire smoke option) must be removed. If your PC1575 is the standard option, then connector CON1 is already removed (please see Appendix D “PGM Output Options” for more information).*
- !** *When using the LINKS, Busy Tone Detection must not be used.*

Keypad Commands

S E C T I O N 3

The PC1575 alarm panel can be accessed, controlled and completely programmed via any keypad on the system. The LED keypad uses function and zone indicator lights to represent alarm functions and status. The LCD keypad provides a written description on the liquid crystal display and uses function indicator lights to communicate alarm status to the user.

The following sections describe how to arm and disarm the system from each type of keypad, and how to perform other keypad functions.

3.1 Arming and Disarming

The system cannot be armed unless the Ready light is ON. In order for the system to be in the Ready state, all protected doors and windows must be secured and all movement in areas covered by motion detectors must cease. When the Ready light is ON, enter any valid access code. As each digit is pressed, the keypad will beep. If the correct code is entered when the system is not in the Ready state, the panel will sound six quick beeps followed by a long two second beep.

If an incorrect code is entered, the keypad will emit a steady two second beep to indicate the invalid access code. When the correct code is entered and the system is Ready, the panel will emit six short beeps and the Armed light will turn ON. Exit the premises through the designated entry/exit door. For other methods of arming, *please refer to section 3.4 (“[*] [0] Quick Exit” and “[*] [9] Arming Without Entry Delay”)* and *section 3.5 (“Function Keys”)*.

In an attempt to prevent false alarms, the **Audible Exit Fault** is designed to notify the user of an improper exit when they arm their system. If a non force-arming Delay 1 or Delay 2 type zone is left open at the end of the exit delay, the entry delay will begin immediately and the bell or siren will sound a steady alarm for the entry delay period. At the end of the entry delay period, if the system has not been disarmed it will go into alarm.

When you enter the premises through a designated entry/exit door while the system is armed, the keypad will emit a steady beep to remind you to disarm the system. Enter a valid access code from any keypad to disarm the system. If an error is made, press the [#] key and enter the code again. When a correct code is entered, the Armed light will turn OFF and the keypad will stop beeping. During the last 10 seconds of entry delay, the panel will pulse the keypad beeper ON and OFF rapidly to warn you that the entry delay is about to expire.

If an alarm occurred while the panel was armed, the Memory light and the zone indicator lights corresponding to the zones which caused the alarm will be flashing. Press the [#] key to return the keypad to the Ready state.

3.2 Auto Bypass – Stay Arming

Stay arming allows the user to arm the system without leaving the premises. All interior zones can be programmed to be bypassed during Stay arming so that the user does not have to bypass interior zones manually.

When the system is armed using a valid user code, if any zones on the system have been programmed as Stay/Away zones, the Bypass light will turn ON. The panel will then monitor all zones programmed as Delay 1 and Delay 2

zones, such as designated entry/exit doors. If no delay type zone is violated by the end of the exit delay, the panel will bypass all Stay/Away type zones. The Bypass light will remain ON to inform the user that the interior protection has been automatically bypassed by the panel. If a delay zone is violated during the exit delay, the Stay/Away zones will be active after the exit delay expires.

The user can add the Stay/Away zones back into the system at any time by entering the [*] [1] keypad command (*see section 3.4 “[*] [1] Zone Bypass”*).

Stay arming can also be initiated by pressing and holding the Stay function key for two seconds on the PC5506 and LCD5500 keypads, if programmed by the installer. For more information regarding Stay arming, please see section 3.5 (“Function Keys”).

3.3 Automatic Arming

The system can be programmed to Auto-Arm at a specific time every day if it is in the disarmed condition.

In order for the Auto-Arm function to work properly, the correct **Time of Day** must be programmed. For programming the clock and Auto-Arm times, see Section 3.4 (“[*] [6] User Functions”).

When the system’s internal clock matches the **Auto-Arm Time**, the panel will check the system status. If the system is armed, the panel will do nothing until the next day at the **Auto-Arm Time**, when it will check the system again. If disarmed, the panel will sound the buzzer of all keypads for one minute. If a valid User Code is entered, Auto-Arming will be aborted. If no code is entered, the panel will Auto-Arm. If a zone is violated, the panel will transmit a **Partial Closing Reporting Code** – if programmed – to indicate to the central station that the system is not secure. If the zone is restored, the panel will add the zone back into the system (*see Section 5.7 “Communicator – Reporting Codes”*).

3.4 [*] Commands

The [*] key commands provide an easy way for the user to access basic system programming – such as entering user codes or bypassing zones. The user can also use the [*] key commands to check on the system’s status, including viewing trouble conditions and displaying the event buffer on the LCD keypad.

The [*] key commands can be performed from both LCD and LED keypads. The LED keypad uses the zone indicator lights to display command information. The LCD display provides written information, guiding the user through each command. The commands in this section are explained as viewed from an LED keypad. When using an LCD keypad, use the arrow keys (< >) to scroll through information provided. Otherwise, the functions remain the same for both keypad types.

[*] [1] Bypassing and Reactivating Stay/Away Zones

The [*] [1] keypad command can be used to bypass individual zones. A bypassed zone will not cause an alarm. The user can bypass zones to gain access to an area while arming the rest of the system or to override a defective

zone—due to a bad contact or damaged wiring—until service can be provided.

If the **Code Required for Bypass** option is enabled, only user codes with the bypass attribute will be able to bypass zones (see Section 5.1 “Programming Security Codes”).

If the **Bypass Status Displayed While Armed** option is chosen, the Bypass light will be ON while the system is armed to indicate any bypassed zones (see Section 5.15 “Arming / Disarming Options”).

! Zones can only be bypassed when the system is disarmed.

To bypass a zone:

1. Enter [★] [1] (and an access code, if required).
2. The keypad will flash the Bypass light. The zone indicator lights corresponding to any zones already bypassed will turn ON.
3. Enter the number corresponding to the zone you wish to bypass. The corresponding zone indicator light will turn ON.
4. Press [#] to exit the function.
All zones whose indicator lights are ON when the [#] key is pressed will be bypassed. The Bypass light will turn ON, indicating that one or more zones are bypassed.

To reactivate a bypassed zone:

1. Enter [★] [1] (and an access code if required).
2. The keypad will flash the Bypass light. The zone indicator lights corresponding to any zones already bypassed will turn ON.
3. Enter the number corresponding to the bypassed zone you wish to reactivate. The corresponding zone indicator light will turn OFF.
4. Press [#] to exit the function.
All zones whose indicator lights are ON when the [#] key is pressed will be bypassed. If no zone indicator lights were ON, the Bypass light will be OFF and no zones will be bypassed.

! When the system is disarmed, all manually-bypassed zones will be unbypassed.

Reactivate Interior

If the system is armed in the Stay mode, the [★] [1] command can be used to reactivate the Stay/Away zones.

! [★] [1] Reactivate Stay/Away cannot be used with an alarm in memory.

! Please ensure all force-armed zones are restored before reactivating the Stay/Away zones (See Section 5.3 “Zone Attributes”).

[★] [2] Trouble Display

The panel constantly monitors itself for several different trouble conditions. If a trouble condition is present, the Trouble light will be ON and the keypad will beep twice every 10 seconds. The trouble beep can be silenced by pressing any key on any keypad.

To view trouble conditions from an LED keypad:

1. Press [★] [2].
2. The keypad will flash the Trouble light. The zone indicator lights corresponding to the present trouble conditions will be ON.

When using an LCD keypad, the trouble conditions will be listed on the display; the user must simply use the arrow (< >) keys to scroll through the list of present trouble conditions. The various troubles are described below:

Trouble [1] – Service Required

If zone indicator light [1] is ON, a “service required” trouble is present. Press [1] to determine the specific trouble. The following is a list of “service required” trouble conditions:

- Light [1] – Low Battery
The main panel backup battery is low. The trouble will be generated if the battery drops below 11.5 volts under load and will be restored when the battery charges over 12.5 volts.
- Light [2] – Bell Circuit Trouble
The panel will indicate this trouble if the Bell fuse is blown or if the panel senses an open condition on the bell circuit (see Section 5.12 “Siren Supervision”).
- Light [3] – General System Trouble
This trouble will be present if the printer connected to the PC5400 Printer module has a fault and is off-line, or if the ESCORT module does not detect the Power Line Interface Module.
- Light [4] – General System Tamper
This trouble will be indicated if any peripheral module tamper is detected.
- Light [5] – General System Supervisory
This trouble will be indicated if the panel loses communication with any module connected to the KEYBUS (see Section 2.6 “Supervision”). The event buffer will log a detailed description of the event.

Trouble [2] – AC Failure

This trouble indicates that AC power is no longer being supplied to the control unit. The reporting codes in sections [43] and [44] can be programmed to communicate a power failure to the monitoring station. To avoid reporting short power failures, an **AC Failure Communication Delay** from 000-255 minutes can be programmed in section [62].

Trouble [3] – Communication Troubles

There are two types of telephone line trouble conditions. Press [3] to display which type of trouble is present:

- [1] – Telephone Line Monitoring Trouble (TLM)
The telephone connection to the control unit is monitored every 10 seconds. If the voltage drops below one to three volts for the number of consecutive checks programmed in section [62], a telephone line trouble is generated. If the system has a LINKS 1000, this trouble can be reported to a monitoring station by programming reporting codes in sections [43] and [44].
- [2] – Failure to Communicate (FTC)
This trouble will be generated if the communicator fails to communicate with any of the programmed telephone numbers. If a later attempt is successful, the FTC

reporting code(s) programmed in section [45] will be transmitted along with the unreported events from an earlier unsuccessful communication.

Trouble [4] – Zone Fault (including Fire Zone)

This trouble will be generated if any zone on the system is experiencing trouble, meaning that a zone could not provide an alarm to the panel if required to do so. When a zone fault trouble condition occurs, the keypad(s) on the system will start to beep.

Press [4] while in Trouble mode to view the affected zones. If 2-wire smoke detectors are being used, a trouble on that zone will be indicated by the "Fire" LED.



A Fire zone trouble will be generated and displayed in the armed state. A Fire zone trouble will also restart the trouble beeps from all keypads.

Trouble [5] – Zone Tamper

This trouble is only generated by zones configured for Double End Of Line resistor supervision when a tamper condition is present. When a tamper condition occurs, the keypad(s) will start to beep. Press [5] while in the Trouble mode to view the affected zones.

Trouble [6] – Loss of System Time

This trouble occurs when the control unit is powered up and the internal clock has not been set. Setting the time with User Function [*][6][Master Code][1] will clear this trouble.

[*] [3] Alarm Memory

The 'Memory' light will be on if any alarm occurred during the last armed period or – in the case of 24 hour zones – if an alarm occurred while the panel was disarmed.

To view alarm memory:

Press [*] [3]. The keypad will flash the Memory light and the zone indicator lights corresponding to the alarm or tamper conditions which occurred during or since the last armed period. To clear the Memory light, arm and disarm the system.

[*] [4] Door Chime On/Off

The door chime feature is used to sound a tone from the keypad whenever a zone programmed as a chime zone is activated (see Section 5.3 – "Zone Attributes"). If the door chime feature is enabled, the keypad will emit five short beeps whenever a chime zone is activated. Designated entry/exit doors are often defined as chime zones; when the feature is enabled, the keypads will sound when an entry/exit door is opened.

To turn Door Chime ON or OFF:

1. Press [*] [4].
2. The keypad will emit three short beeps if the Door Chime feature is enabled and one long beep when disabled.

The function can also be performed by pressing and holding the Chime function key for two seconds on any PC5506 or LCD5500 keypad.

[*] [5] Programming Access Codes

There are 6 access codes available to the user. They are as follows:

- Access code (1) One Master Code
- Access codes (2) to (6) Five User Codes

All access codes have the ability to arm or disarm the system and can activate the PGM Outputs using the [*] [7] [1] [Access Code] and [*] [7] [2] commands.

Master Code – Access Code (1)

By default, the Master Code is enabled to perform any keypad function. This code can be used to program all User Codes. If the **Master Code Not Changeable** option is enabled, the Master Code can only be changed by the Installer.

User Codes – Access Codes (2) to (6)

User codes can arm and disarm the system. By selecting the **No Code Required for Bypassing** option, each user can also have the ability to bypass zones without entering an access code.

Duress Code – Access Code (6)

If the **Sixth Code is Duress Code** option is enabled, the sixth code can be programmed by the user as a Duress Code which will send a Duress reporting code to the central station when entered.

For more information regarding access code options, please see Section 5.1 – "Programming Security Codes."

How to program User Codes:

1. Enter [*] [5] [Master Code]. The keypad will flash the Program light. The zone indicator lights corresponding to access codes already programmed will turn ON.
2. Enter the number corresponding to the code you wish to program. The corresponding zone light will flash.
3. Enter a 4 digit code. The zone light will turn ON.
4. Continue from step 2 until all codes are programmed. Once the process is complete, press the [#] key to return to the Ready state.



Do not press [*] or [#] when programming the 4 digit code.

How to erase an Access Code:

Enter [*] [5] [Master Code], select the code to be erased and press [*].

[*] [6] User Functions

This keypad command can be used to program several different functions. The programmable items are listed and described below.

To program User Functions:

1. Press [*] [6] [Master Code]. The Program light will flash.
2. Press the number [0] to [9] for the item to be programmed.

• [1] – Time and Date

The time and date must be accurate for the Auto-Arm or Test Transmission functions to work properly and for the event buffer to time and date stamp all events.

- Enter the time (hour and minute) using military format [HH MM] from 00:00 to 23:59.
- Enter the date by month, day and year [MM DD YY].

- **[2] – Auto-Arm Enable/Disable**
Auto-Arming will not work unless it is enabled for the system. To enable or disable auto-arming, press [2]. The keypad will emit three short beeps if the Auto-Arm feature is enabled and one long beep when disabled. For more information, see Section 3.3 – “Auto-Arming”.
- **[3] – Auto-Arm Time**
The system can be programmed to Auto-Arm at a certain time. When programming the auto-arming time, enter the time (hour and minute) using military format [HH MM]. For more information, see Section 3.3 – “Auto-Arming”.
- **[4] – System Test**
When [4] is pressed the panel will test the bell output, keypad lights and the communicator for two seconds. The panel will also send a System Test Reporting code, if programmed (see Section 5.7 – “Communicator – Reporting Codes”).
- **[5] – Enable DLS (Downloading)**
When [5] is pressed, the panel will enable the downloading option for one hour. During this time, the panel will answer incoming downloading calls (see Section 5.9 “Downloading”).
- **[6] – User Initiated Call-Up**
When [6] is pressed, the panel will initiate call-out to the downloading computer.
- **[7] and [9] – Last Code to Disarm and Arm**
Pressing [7] will display the last code to disarm the system and then pressing [9] will display the last code to arm the system.
- **[0] – Walk Test Enable / Disable**
The Installer Walk Test can be used to verify that each zone of the panel is functioning properly. Any zone violated during a walk test will cause the panel to activate the Bell Output for two seconds, log the event to the Event Buffer and communicate the alarm to central station.

Additional Features using the LCD Keypad
Additional features, including access to the Event Buffer, are available using the LCD keypad. Use the arrow keys (< >) to scroll through the [★] [6] menu and press the [★] key to select the following commands:

Viewing the Event Buffer from an LCD Keypad
Select “View Event Buffer” from the [★] [6] menu. The keypad will display the event, event number, time and date along with the zone number and user code, if applicable. Press [★] to toggle between this information and the event itself. Use the arrow keys (<>) to scroll through the events in the buffer. When you have finished viewing the Event Buffer, press the [#] key to exit.

Brightness Control
The LCD keypad will allow you to select from 10 different backlighting levels. Use the arrow keys (< >) to scroll to the desired backlighting level and press the [#] key to exit.

Contrast Control
The LCD keypad will allow you to select from 10 different display contrast levels. Use the arrow keys (< >) to scroll to the desired contrast level and press the [#] key to exit.

Keypad Beeper Control
The LCD keypad will allow you to select from 21 different keypad beeper tones. Use the arrow keys (< >) to scroll to the desired keypad beeper level and press the [#] key to exit. This featured can be accessed on LED keypads by holding the [★] key.

[★] [7] **Output Functions**
There are two output functions available to the user: Utility Output and Sensor Reset.

To activate Utility Output:
Press [★] [7] [1] [Access Code]. The panel will activate all PGM Outputs programmed as utility outputs for five seconds (see Appendix D – “PGM Output Options”).

To activate Sensor Reset:
Press [★] [7] [2]. The panel will activate all PGM Outputs programmed as Sensor Reset for five seconds. This command will also reset 2-wire smoke detectors connected to PGM2 if programmed to do so (see Appendix D – “PGM Output Options”).

This function can also be performed by pressing and holding the Reset function key for two seconds on any PC5506 or LCD5500 keypad.

[★] [8] **Installer’s Programming**
Enter [★] [8] followed by the Installer’s Code to enter this function. Installer’s Programming is outlined in detail in Sections 4 and 5 of this manual.

[★] [9] **Arming Without Entry Delay**
When the system is armed with the [★] [9] command, the panel will cancel the entry delay. Once the exit delay has expired, Delay 1 and Delay 2 type zones will be instant and Stay/Away zones will be bypassed (see Section 5.2 – “Zone Definitions”). A valid access code must be entered after pressing [★] [9].

[★] [0] **Quick Arm**
If the Quick Arm option is enabled, the panel can be armed without a user code by entering [★] [0] (See Section 5.15 “Arming / Disarming Options”).

! Quick Arm cannot be used to cancel auto arm.

Quick Exit
The Quick Exit function, if enabled, will allow someone to leave an armed premises through a Delay type zone without having to disarm and rearm the system (See Section 5.15 “Arming / Disarming Options”).

When [★] [0] is entered, the panel will provide a two minute window for the user to exit the premises. During this time, the panel will ignore *only one* activation of a Delay zone. When the Delay zone is secured, the panel will end the two minute quick exit delay.

If a second Delay zone is tripped, or if the zone is not restored after two minutes, the panel will begin the entry delay.

! If the Exit Delay is in progress, performing a Quick Exit will not extend the Exit Delay.

3.5 Function Keys



The function keys only appear on the PC5506 and LCD5500 keypads

There are five function keys on the PC5506 and LCD5500 keypads located to the right of the number pad labelled Stay, Away, Chime, Reset and Exit. Each of these keys is programmed by default to perform one of the functions described below. A function is activated by pressing and holding the appropriate key for two seconds.

“Stay” – Stay Arm

Pressing this key will arm the system in the Stay mode, meaning that all Stay/Away type zones will be automatically bypassed. Delay type zones will provide entry and exit delay. The Quick Arm feature must be enabled in order for this key to function (programming section [10], option [6]).

“Away” – Away Arm

Pressing this key will arm the system in the Away mode. All Stay/Away type zones and all other non-bypassed zones will be active at the end of the exit delay. Delay type zones will provide entry and exit delay. The Quick Arm feature must be enabled in order for this key to function.

“Chime” – Door Chime On / Off

Pressing this key will toggle the Door Chime feature ON or OFF. One solid beep means that the feature has been disabled and three short beeps means that it has been enabled (see [Section 3.4 – “\[*\] \[4\] Door Chime”](#)).

“Reset” – Reset Smoke Detectors

Pressing this key will cause the panel to activate for five seconds all PGM outputs programmed as Sensor Reset. In addition, 2-wire smoke detectors connected to PGM2 will also be reset (See [Section 3.4 – “\[*\] \[7\] \[2\] Output Functions”](#)).

“Exit” – Activate Quick Exit

Pressing this key will cause the panel to activate the Quick Exit feature (See [Section 3.4 – “\[*\] \[0\] Quick Exit”](#)).

3.5.1 Function Key Options

The following is a list of Function Key options available. Each option is listed according to their programming code, followed by their corresponding [*] key command. For more information regarding each function, please refer to the appropriate segment in section 3.4 (“[*] Commands”)

[00] – Null Key

The key is not used and will perform no function when pressed.

[01]-[02]– Not Used

[03] – Stay Arm

Same as described in Function Keys – Section 3.5.

[04] – Away Arm

Same as described in Function Keys – Section 3.5.

[05] – [*] [9] No-Entry Delay Arm

Once this function key is pressed the user must enter a valid user code. The system will arm and remove the entry delay from the system when the exit delay expires (see [Section 3.4 – “\[*\] \[9\] Arming Without Entry Delay”](#)).

[06] – [*] [4] Door Chime On / Off

Same as described in Function Keys – Section 3.5.

[07] – [*] [6] [----] [4] System Test

This function key provides the user with a simple method for testing the system.

[08] – [*] [1] Bypass Mode

This function key provides the user with a simple method for entering the Bypass Mode. If a user code is required, it must be entered before zone bypassing can be performed.

[09] – [*] [2] Trouble Display

This function key provides the user with a simple method for entering the Trouble Display Mode.

[10] – [*] [3] Alarm Memory

This function key provides the user with a simple method for entering the Alarm Memory Display Mode.

[11] – [*] [5] Programming Access Codes

This function key provides the user with a simple method for programming user codes. Once this key is pressed, a valid master code must be entered before the panel will allow programming to be performed.

[12] – [*] [6] User Functions

This function key provides the user with a simple method for programming user functions. Once this key is pressed, the Master code must be entered before the panel will allow user functions to be performed.

[13] – [*] [7] [1] Utility Output

This function key provides the user with a simple method for activating a PGM Output programmed as utility output (see [Appendix D – “PGM Output Options”](#)). Once this key is pressed, a valid user code must be entered.

[14] – [*] [7] [2] Sensor Reset

Same as described in Function Keys – Section 3.5.

[15] – Not Used

[16] – [*] [0] Quick Exit

Same as described in Function Keys – Section 3.5.

[17] – [*] [1] Reactivate Stay/Away Zones

This function key provides the user with a simple method for adding Stay/Away zones back into the system at night-time (see [Section 3.4 – “\[*\] \[1\] Bypassing and Reactivating Stay/Away Zones”](#)).

How to Program

S E C T I O N 4

The following section of the manual describes the Installer's Programming function and how to program the various sections.

! *You must read the following section of the manual very carefully before you begin programming. We also recommend filling out the Programming Worksheets section before you program the panel.*

.....
For your reference, the corresponding programming sections for the functions listed are highlighted in text boxes such as this one.
.....

4.1 Installer's Programming

Installer's Programming is used to program all communicator and panel options. The **Installer's Code** is [1575] by default but may be changed to prevent unauthorized access to programming.

.....
Installer Code **Section [03]**
.....

From an LED Keypad:

- Step 1** Enter [*] [8] [Installer's Code].
- The Program light (if present) will flash to indicate that you are in programming mode.
 - The Armed light will turn ON to indicate that the panel is waiting for the two digit programming section number.
- Step 2** Enter the two digit Section number corresponding to the section you wish to program.
- The Armed light will turn OFF.
 - The Ready light will turn ON to indicate that the panel is waiting for the information required to complete programming the selected section.
- Step 3** Enter the information required to complete section programming (ie: numbers, HEX data, or ON/OFF options).

! *If the two digit Section numbered entered is invalid, or if the module which pertains to the section is not present, the keypad will sound a two second error tone.*

From an LCD Keypad:

- Step 1** From any keypad, enter [*] [8] [Installer's Code]. The Keypad will display 'Enter Section' followed by two dashes.
- Step 2** Enter the two digit number corresponding to the programming section number you wish to program. The keypad will now display the information required to complete programming the selected section.
- Step 3** Enter the information required to complete section programming (ie: numbers, HEX data, or ON/OFF options).

If you enter information into a section and make a mistake, press the [#] key to exit the section. Select that section again and re-enter the information correctly.

4.2 Programming Decimal Data

A set number of programming boxes are allotted for each section requiring decimal data (e.g.: codes, telephone numbers). If a digit is entered for each program box, the panel will automatically exit from the selected programming section. The Ready light will turn OFF and the Armed light will turn ON.

You can also press the [#] key to exit a programming section without entering data for every box. This is handy if you only need to change digits in the first few programming boxes. All other digits in the programming section will remain unchanged.

4.3 Programming HEX Data

On occasion, hexadecimal (HEX) digits may be required. To program a HEX digit press the [*] key. The panel will enter HEX programming and Ready light will begin to flash.

The following are the numbers which should be pressed to enter the appropriate HEX digit:

1 = A 2 = B 3 = C 4 = D 5 = E 6 = F

Once the correct HEX digit has been entered, the Ready light will continue to flash. If another HEX digit is required, press the corresponding number. If a decimal digit is required, press the [*] key again. The Ready light will turn ON and the panel will return to regular decimal programming.

Example:

To enter 'C1' for a closing by user 1, you would enter
[*] [3] [*] , [1]
[*] to enter Hexadecimal mode (Ready light flashes)
[3] to enter C
[*] to return to decimal mode (Ready light is solid)
[1] to enter digit 1

! *If Ready light is flashing, any number you enter will be programmed as the HEX equivalent.*

If you are using a pulse format, a decimal zero [0] does not transmit. Programming a zero [0] tells the panel not to send any pulses for that digit. Decimal zero [0] is a filler digit. To transmit a zero [0], it must be programmed as a Hexadecimal 'A'.

Example:

For the three digit account number '403', you would enter
[4], [*] [1] [*] [3], [0].
[4] to enter the digit 4
[*] to enter Hexadecimal mode (Ready light flashes)
[1] to enter A; [*] to return to decimal mode (Ready light is solid)
[3] to enter the digit 3
[0] to enter the digit 0 as a filler digit.

4.4 Programming Toggle Option Sections

Some Sections contain several toggle options. The panel will use zone lights 1 through 6 to indicate if the different options are enabled or disabled. Press the number corresponding to the option to turn it ON or OFF. Once all the toggle options have been selected correctly, press the [#] key to exit the section and save the changes. The Ready light will turn OFF and the Armed light will turn ON.

Refer to Section 5 in this manual to determine what each option represents and whether the light should be ON or OFF for your application.

4.5 Viewing Programming

LED Keypads

Any programming section can be viewed from an LED keypad. When a programming section is entered, the keypad will immediately display the first digit of information programmed in that section.

The keypad displays the information using a binary format, where

Zone Light 1 = 1	Zone Light 2 = 2
Zone Light 3 = 4	Zone Light 4 = 8

Add up the values for the zone lights to determine the number displayed (for example, no zone lights = 0, all 4 zone lights = 15 HEX 'F').

Press any of the Emergency Keys (Fire, Auxiliary or Panic) to advance to the next digit. When all the digits in a section have been viewed, the panel will exit the section; the Ready Light will turn OFF and the Armed light will turn ON, waiting for the next two digit programming section number to be entered. Press the [#] key to exit the section

LCD Keypad

When a programming section is entered, the keypad will immediately display all the information programmed in that section.

Use the arrow keys (< >) to scroll through the data being displayed.

Scroll past the end of the data displayed or press the [#] key to exit the section.

Program Descriptions

S E C T I O N 5

The following section explains the operation of all programmable features and options and provides a summary of all corresponding programming locations.

5.1 Programming Security Codes

There are three codes which can be programmed by the installer in the Installer's Programming function: the Master Code, a Second Master Code, and the Installer's Code. All other access codes can be programmed through the [★] [5] command (see Section 3.4).

The Master Code can also be programmed by the user as access code (1). If the **Master Code Not Changeable** option is enabled, the System Master Code can only be changed by the Installer.

User codes can arm and disarm the system. By selecting the **No Code Required for Bypassing** option, each user code can also have the ability to bypass zones without entering the Master Code.

If the **Sixth Code is Duress Code** option is enabled, the sixth code can be programmed by the user as a Duress Code which will send a Duress Reporting Code to the central station when entered.

.....

Installer's Code	Section [03]
Master Code	Section [04]
Second Master Code	Section [05]
Master Code Not Changeable	Section [09], option [1]
No Code Required for Bypassing ..	Section [09], option [2]
Sixth Code is Duress Code	Section [09], option [3]

.....

5.2 Zone Definitions

These sections will allow you to select how each of the 6 zones will operate. Each zone requires a two digit entry. In addition to zone definitions, six different attributes may be programmed by zone (see Section 5.3 – "Zone Attributes").

- [00] Null Zone**
The zone is vacant. Unused zones should be programmed as Null zones.
- [01] Delay 1**
This zone type, normally used for entry/exit doors, can be violated during the exit delay time without causing an alarm. Once the exit delay has expired, opening the zone will start the entry delay timer. During the entry delay time, the keypad buzzer will sound steadily to advise the user that the system should be disarmed. If the panel is disarmed before the entry time expires, no alarm will be generated.
- [02] Delay 2**
The Delay 2 entry delay time can be set independent of Delay 1 in programming section [02] (System Times).
- [03] Instant Zone**
This zone type will cause an instant alarm if it is violated when the panel is armed. Typically, this zone is used for windows, patio doors or other perimeter zones.
- [04] Interior Zone**
This zone will not cause an alarm if violated during the entry delay. If the zone is violated before the entry delay has

begun, it will cause an instant alarm. Typically, this zone is used for interior protection devices, such as motion detectors.

- [05] Interior Stay/Away Zone**
This zone type works similar to the Interior zone type except that it will be automatically bypassed under the following conditions:
 - When the panel is armed in the Stay Mode (see Section 3.5 – "Function Keys").
 - When the panel is armed without entry delay (see Section 3.4 – "[★] [9] Arming Without Entry Delay").
 - When the panel is armed with a user code and a Delay type zone is NOT tripped during the exit delay.The automatic bypass prevents the user from having to manually bypass interior type zones when arming at home. This zone is typically used for interior protection devices, such as motion detectors.
- [06] Delay Stay/Away Zone**
This zone type will operate similar to Interior Stay/Away zones except that it will always provide an entry delay. Typically, this zone is used for interior protection devices, such as motion detectors. This zone option will help prevent false alarms since it always provides an entry delay time for the user to turn off the panel.
- [07] Delayed 24 Hour Fire Zone**
When this zone is violated, the alarm output will be immediately activated but the communicator will be delayed for 30 seconds. If the user presses any key on any keypad during this delay, the alarm output and the communicator will be delayed an additional 90 seconds, giving the user time to correct the problem. If the zone is still violated after the 90 second delay, the panel will sound the alarm output and delay the communicator for 30 seconds. If the user does not press a key during the 30 second delay, the alarm output will latch and the panel will communicate the alarm to the central station. The alarm will sound for the Bell Cutoff time programmed in Section [02] ("System Times").

! *If a second Fire type zone is violated or if the Fire keys are pressed during the delay period, the panel will latch the alarm output and will immediately communicate the alarm.*

A violated Fire zone will be displayed on all keypads and can be delayed at any keypad. Typically this zone is used for latching smoke detectors.
- [08] Standard 24 Hour Fire Zone**
When this zone is violated, the panel will immediately latch the alarm output and communicate to the central station. The alarm will sound for the Bell Cutoff time programmed in Section [02] ("System Times").
A violated Fire zone will be displayed on all keypads. Typically this zone is used for pull stations.
- [09] 24 Hour Supervisory Zone (with LINKS)**
If this zone is violated when the system is either armed or disarmed, the panel will report to the central station, and will log the zone fault to the Event Buffer.

[10] 24 Hour Supervisory Buzzer Zone

If this zone is violated when the system is either armed or disarmed, the panel will immediately latch the keypad buzzer until a valid user code is entered and will immediately communicate to the central station.

[11] 24 Hour Burglary Zone

If this zone is violated when the system is either armed or disarmed, the panel will immediately latch the alarm output and communicate to the central station. The alarm will sound for the Bell Cutoff time programmed in Section [02] ("System Times") or until a valid user code is entered.

[12] -[20]

The following zone definitions operate similar to the 24 Hour Burglary except for the System Event output type and the SIA identifier:

- [12] 24 Hour Heat Zone**
- [13] Not Used**
- [14] 24 Hour Holdup Zone**
- [15] 24 Hour Auxiliary Zone**
- [16] 24 Hour Panic Zone**
- [17] 24 Hour Intrusion Emergency Zone**
- [18] 24 Hour Sprinkler Zone**
- [19] 24 Hour Water Flow Zone**
- [20] 24 Hour Freezer Zone**

[21] 24 Hour Latching Tamper

If this zone is violated, the installer must enter Installer's Programming before the system can be armed.

5.3 Zone Attributes



All zones, with the exception of 24 Hour and Fire, have an exit delay. When the system is armed, the zones may be violated during the exit delay without causing an alarm. Attributes for Fire Zones should not be changed from the default settings.

Additional zone attributes can be programmed to customize the operation of a zone for a specific application. The following attributes are programmable for each zone:

- **Audible / Silent** – This attribute determines whether or not the zone will activate the alarm output.
- **Pulsed / Steady** – This attribute determines whether the alarm output will be steady or will pulse ON and OFF every second.
- **Activate Chime** – This attribute determines whether or not the zone will activate the chime feature (see Section 3.4 – "[*] [4] Door Chime On/Off").
- **Bypass Enable** – This attribute determines whether or not the zone can be manually bypassed (see Section 3.4 – "[*] [1] Bypassing and Reactivating Stay/Away Zones").
- **Force Arm Enable** – This attribute determines whether or not the system can be armed while a zone is violated. At the end of the exit delay, if this type of zone is violated, it will be ignored by the panel. Once the zone is secured, it will be monitored by the system. This zone attribute, for example, will allow the user to arm the system with the garage door open. Later, when the door is closed, it will be armed along with the rest of the system.
- **Downlook Activation Option (Video)** – If enabled, this attribute will activate the DLM-1/DLM-4 Downlook module. When a given zone goes into alarm, it will activate the DLM to take a picture of that zone.

.....
Zones Attributes Sections [21] - [26], Options [1] - [6]

5.4 Communicator – Dialing

If the **Communicator Disable** option is selected, the panel will not attempt to call central station. If communication is enabled, the panel will attempt to call central station when an event with a valid Reporting Code occurs (See Section 5.7 "Communicator – Reporting Code").

The **Communicator Call Direction** Options are used to select which phone number the panel will dial when an event occurs.

If the **DTMF Dialing** option is enabled, the panel will dial using DTMF (touch tone). If the **Switch to Pulse Dial** option is enabled, the panel will switch to pulse dialing on the fifth attempt to call the central station. When this option is disabled, the panel will always dial using DTMF. If **DTMF Dialing** is disabled, the panel will always pulse dial.

If the **Busy Tone Detection** option is enabled, the panel will hang up and redial 60 seconds after having detected a busy tone for four seconds.

The panel will attempt to send a signal to central station eight times before indicating a Failure to Communicate (FTC) trouble condition. The Third Phone Number can be used as a back up for the first number in this situation (see Section 5.6 "Communicator – Phone Numbers").

.....
DTMF or Pulse Dialing Section [60], Option [2]
Switch to Pulse Dialing on 5th attempt Section [60], Option [3]
Communicator Enable/Disable Section [60], Option [1]
Communicator Call Direction Options Section [51] to [55]
Busy Tone Detection Section [61], Option [4]

5.5 Communicator – Account Numbers

The account number is used by the central station to distinguish between panels. There are two account numbers programmable for the PC1575.

.....
First Account Code (4 digits) Section [34]
Second Account Code (4 digits) Section [35]

5.6 Communicator – Phone Numbers

The panel can use three different phone numbers for communicating with the central station. The **First Phone Number** is the primary number, the **Second Phone Number** is the secondary number and the **Third Phone Number** will back up the First phone number if enabled.



The Third Phone Number will NOT back up the Second Phone Number.

If the **Alternate Dial** option is enabled, the panel will alternate between the first and third phone numbers when attempting to call the central station. If the option is disabled, the panel will only attempt to call the Third phone number after failing to communicate with the first phone number.



In order for Alternate Dialing to work properly, the Third Phone Number must be enabled.

Phone numbers can be up to 32 digits which will allow you to add special digits if required. To program the phone number, enter the numbers 0 through 9 as required. The following is a list of programmable HEX digits and the function they perform:

- HEX (B) - simulates the [*] key on a touch tone phone
- HEX (E) - forces the panel to pause for 2 seconds
- HEX (C) - simulates the [#] key on a touch tone phone
- HEX (F) - marks the end of the phone number
- HEX (D) - forces the panel to search for dial tone

- First Phone Number Section [31]*
- Second Phone Number Section [32]*
- Third Phone Number Section [33]*
- Third Phone Number Enable Section [60], Option [4]*
- Alternate Dial Section [60], Option [5]*

! *If no Dial Tone Detect (HEX D) is used in the phone number, a 2-second pause (HEX E) should be inserted.*

5.7 Communicator – Reporting Codes

The panel can be programmed to report events to the central station by sending the Reporting Code programmed for a particular event.

Reporting codes can be one or two digits and can use HEX digits (A through F). The following is a description of the different Reporting Codes that can be programmed and when the events will be reported to central station.

- Reporting Codes Section [36] to [46]*

5.7.1 Zone Alarm

The panel will transmit the **Zone Alarm** Reporting Code when a zone goes into alarm. 24 hour type zones will go into alarm whether the panel is armed or disarmed and report to the central station. All other types of zones will only go into alarm if the panel is armed. The **Police Code** reporting code will be sent after 2 zones have gone into alarm within the same armed period.

- Zone Alarm Reporting Codes Section [36]*
- Police Code Reporting Code Section [36]*

! *Only Zone Alarms will count towards the Police Code*

5.7.2 Zone Restoral

If the **Restoral on Bell Time-out** option is selected, the panel will send the **Zone Restoral** Reporting Code for the zone if the alarm output times out *and* the zone is secured. If the zone is not secured when the alarm output times out, the panel will send the restoral immediately once the zone is secured.

If the **Restoral on Bell Time-out** option is not selected, the panel will immediately send the **Zone Restoral** Reporting Code when the zone is secured, regardless of whether or not the alarm output is active.

! *24 Hour type zones will report the restoral immediately once the zone is secured.*

- Zone Restoral Reporting Codes... Section [37], Option [6]*
- Restoral on Bell Time-out Section [60], Option [6]*

5.7.3 Closings (Arming Codes)

The panel will transmit a **Closing** Reporting Code to indicate that the system is armed. A different Reporting Code can be transmitted for each User Code and Master Code to identify who has armed the system.

If programmed, a **Partial Closing** Reporting Code will be sent along with the **Closing** Reporting Code if one or more zones were manually bypassed when the system was armed to warn the monitoring station of a security compromise.

If the **Closing Confirmation** option is enabled, the keypad will sound a series of eight beeps to confirm to the user that the closing code was sent and received by the central station.

- Closing (Arming) Reporting Codes Section [41], Option [6]*
- Partial Closing Reporting Code Section [41]*
- Closing Confirmation Section [61], Option [1]*

5.7.4 Openings (Disarming Codes)

The panel will transmit an **Opening** Reporting Code to indicate that the system has been disarmed. A different Reporting Code can be transmitted for each User Code and the Master Code to identify who has disarmed the system.

If the **Opening After Alarm Keypad Ringback** option is enabled, the keypad will emit a series of eight beeps after an Opening Reporting Code was sent and received by the monitoring station. If the **Opening After Alarm Bell Ringback** option is enabled, the bell will squawk eight times instead of the keypad to notify the user of a successful transmission.

! *The Opening After Alarm code must be programmed when the Transmission Delay is being used. See Section 5.17 “Transmission Delay”.*

- Opening (Disarming) Reporting Codes . Section [42], Option [6]*
- Opening After Alarm Keypad Ringback . Section [61], Option [2]*
- Opening After Alarm Bell Ringback Section [61], Option [3]*

5.7.5 Tamper

If the panel is programmed for Double EOL zones (*see Section 2.8 – “Zone Wiring”*), the panel will report a **Zone Tamper Alarm** Reporting Code if an open condition is present. A different Reporting Code can be programmed to identify each zone. The **Zone Tamper Restoral** Reporting Code will be transmitted immediately when the tamper condition is restored.

A **General System Tamper** Reporting Code will be transmitted when the tamper zone on any module is violated. The **General System Tamper Restoral** Reporting Code will be transmitted when the tamper zone on the module is restored.

- Tamper Alarm Reporting Codes Section [38]*
- General System Tamper Alarm Section [38]*
- Tamper Restoral Reporting Codes Section [39]*
- General System Tamper Restoral Section [39]*

5.7.6 Priority/Emergency

The panel will transmit a **Keypad Fire Alarm** Reporting Code *and* the **Keypad Fire Restoral** Reporting Code when

the Fire Keys on any keypad are pressed for two seconds. The panel will transmit a **Keypad Auxiliary Alarm** Reporting Code and the **Keypad Auxiliary Restoral** Reporting Code when the Auxiliary Keys on any keypad are pressed for two seconds.

The panel will transmit a **Keypad Panic Alarm** Reporting Code and the **Keypad Panic Restoral** Reporting Code when the Panic Keys on any keypad are pressed for two seconds.

The panel will transmit a **Duress** Reporting Code any time the Duress Code is entered at any keypad.

If PGM2 is being used for 2-wire smoke detectors or 24 hour operation, the panel will send a **PGM2 Alarm** Reporting Code if the zone goes into alarm (see Appendix D – “PGM Output Options”). The panel will transmit the **PGM2 Restoral** Reporting Code when the zone is restored.

.....
Maintenance Alarm Reporting Codes Section [43]
Maintenance Restoral Reporting Codes Section [44]
AC Failure Communication Delay Section [62]
.....

5.7.8 Test Transmissions

The panel can be programmed to transmit a **Periodic Test Transmission** Reporting Code (see Section 5.13 – “Test Transmissions”), a **System Test** Reporting Code (see Section 3.4 – “[*] [6] User Functions”) or a **LINKS 1000 Test Transmission** Reporting Code (see Section 5.23 – “LINKS 1000 Cellular Communicator”).

.....
Test Transmission Reporting Codes Section [46]
.....

5.7.9 Miscellaneous

If the panel fails to transmit information to the central station, it will display a Failure To Communicate (FTC) trouble condition. The panel will transmit a **Phone Number 1 Failure to Communicate** Reporting Code or a **Phone Number 2 Failure to Communicate** Reporting Code the next time it calls the central station. The panel will transmit the old events, followed by the FTC message, followed by the new events. This will allow central station to determine which events are old or new.

If the Event Buffer is uploaded or printed on-site on a regular basis, an **Event Buffer 75% Full** Reporting Code can be transmitted to warn that the buffer is almost full. This code is good for use with the PC5400 Printer Module.

The **General Zone Fault Alarm** Reporting Code is sent whenever a DEOL hardwired zone is shorted out. The faulted zone will also be displayed in the Trouble section. The **General Zone Fault Restoral** Reporting Code will be sent when the problem zone is repaired.

The **Delinquency** Reporting Code is sent whenever the panel is not armed within the number of days programmed for the **Delinquency Transmission Delay**.

.....
Miscellaneous Maintenance Reporting Codes Section [45]
Delinquency Transmission Delay Section [62]
.....

! *If the Delinquency Tx Delay is set for 1 day, there must be 24 hours of no arming or disarming before the Delinquency Code will be sent.*
After a Delinquency Code has been transmitted, it will not send again until the system has been armed and disarmed.

! *The above is only applicable to pulse format.*

.....
Priority Alarm and Restoral Reporting Codes Section [40]
.....

5.7.7 Maintenance

The panel will transmit a **Battery Trouble Alarm** Reporting Code when the backup battery charge drops below 11.5 Vdc. The **Battery Trouble Restoral** Reporting Code will not be transmitted until the battery has been charged to over 12.5 Vdc.

To prevent the panel from transmitting an **AC Failure Trouble Alarm** Reporting Code during short power outages, the panel will not send the signal unless AC power is lost for the amount of minutes programmed for the **AC Failure Communication Delay**. The **AC Failure Trouble Restoral** Reporting Code will be transmitted as soon as AC power is restored.

A **Bell Circuit Trouble Alarm** Reporting Code will be transmitted immediately when an open condition is measured for the Bell Output of the main panel. The **Bell Circuit Trouble Restoral** Reporting Code will be transmitted as soon as the problem is corrected.

A **Fire Trouble Alarm** Reporting Code will be immediately transmitted when an open condition is measured on any Fire type zone (see Section 5.2 – “Zone Definitions”). The **Fire Trouble Restoral** Reporting Code will be transmitted as soon as the problem is corrected.

The **Auxiliary Power Supply Trouble Alarm** Reporting Code will be transmitted if the AUX output is shorted out. The AUX output of the control incorporates a fuseless design. When excessive current is drawn, the panel will automatically shut off the output. The panel will constantly check the AUX output; when the excessive current draw is removed, the panel will reset the output and transmit an **Auxiliary Power Supply Trouble Restoral** Reporting Code.

A **TLM Trouble** Reporting Code can only be transmitted if a LINKS 1000 Cellular Communicator is being used (see Section 5.23 “LINKS 1000 Cellular Communicator”). The panel will only transmit the signal after the time programmed for the TLM Trouble Delay. The **TLM Restoral** Reporting Code will be transmitted within 10 seconds of the problem being corrected.

A **General System Supervisory Trouble** Reporting Code will be transmitted if any module goes missing from the KEYBUS. The panel will send a **General System Supervisory Restoral** Reporting Code when the problem is corrected.

5.8 Communicator – Reporting Formats

Each central station communication phone number can be programmed to report using any one of the 4 formats available. A 20 BPS pulse format is supported in addition to Contact ID, SIA and a Pager format.

.....
Communicator Format Options Section [50]
Communicator Call Directions Section [51] to [55]
.....

The following is a description of each reporting format:

5.8.1 Pulse Formats

Depending on which pulse format is selected, the panel will communicate using the following specifications:

- 3/1, 3/2, 4/1 or 4/2
- 20 bits per second
- 1400 or 2300 Hz handshake
- non-extended

Additional Notes on Pulse Formats

1. The digit '0' will send no pulses and is used as a filler digit.
2. When programming account numbers, enter four digits. When programming a three digit account number, the fourth digit must be programmed as '0'.
 - 3 digit account number [123] - program [1230]
3. If an account number has a '0' in it, substitute a HEX digit 'A' for the '0'. For example:
 - 3 digit account number [502] - program [5A20]
 - 4 digit account number [4079] - program [4A79]
4. Reporting codes are two digits. When programming single-digit Reporting Codes, the second digit must be programmed as a '0'. If a '0' is to be transmitted, substitute HEX digit 'A'. For example:
 - 1 digit Reporting Code [3] - program [30]
 - 2 digit Reporting Code [30] - program [3A]
5. To prevent the panel from reporting an event, the Reporting Code should be programmed as [00] or [FF].

5.8.2 Contact ID

Contact ID is a specialized format that will communicate information using tones rather than pulses. This format allows more information to be sent faster than other formats. For example, in addition to reporting an alarm in zone one, the Contact ID format will also report the type of alarm, such as an Entry/Exit alarm.

To program Contact ID, a two digit number from Appendix A must be entered in order for every event to be transmitted. The two digit number determines the type of alarm. The panel will automatically generate all other information, including the zone number.

Additional Notes on Contact ID

1. Account Numbers must be four digits.
 2. All Reporting Codes must be two digits.
 3. Substitute the HEX digit 'A' for the '0'.
 4. To prevent the panel from reporting an event, the Reporting Code should be programmed as [00] or [FF].
- Please refer to Appendix A for a list of Contact ID Identifiers.

5.8.3 SIA

SIA is a specialized format that will communicate information quickly using Frequency Shift Keying (FSK) rather than pulses. The SIA format will automatically generate the type of signal being transmitted, such as Burglary, Fire, Panic etc. The two digit Reporting Code is used to identify the zone or user code number.

! *If the SIA format is selected, the panel can be programmed to automatically generate all zone and user code numbers, thus eliminating the need to program these items.*

If the **SIA Sends Automatic Reporting Codes** option is enabled, the panel will operate as follows:

1. If an event's Reporting Code is programmed as [00], the panel will not attempt to call the central station.

2. If the Reporting Code for an event is programmed as anything from [01] to [FF], the panel will *automatically* generate the zone or user code number.

The Communicator Call Direction options can be used to disable the reporting of events such as Openings and Closings. If all of the Opening and Closing Reporting Codes are programmed as [00], the panel will not report.

If the **SIA Sends Automatic Reporting Codes** option is disabled, the panel will operate as follows:

1. If an event's Reporting Code is programmed as [00] or [FF], the panel will not attempt to call central station.
2. If the Reporting Code for an event is programmed as anything from [01] to [FE], the panel will send the programmed Reporting Code.

Please refer to Appendix B for a list of SIA identifiers.

.....
SIA Sends Automatic Reporting Codes. Section [61], Option [6]

5.8.4 Pager Format

The **Communicator Format** option for either phone number can be programmed as the Pager Format. If an event occurs and the **Communicator Call Direction** options direct the call to a phone number with the Pager Format selected, the panel will attempt to page.

When calling a pager, extra digits will be required in order for the format to function properly. The following is a list of Hex digits and the functions they perform:

- Hex [B] - simulates the [★] key on a touch tone phone
- Hex [E] - two second pause
- Hex [C] - simulates the [#] key on a touch tone phone
- Hex [F] - marks the end of the phone number
- Hex [D] - forces the panel to search for dial tone

The panel will attempt to call the pager once. Once the appropriate phone number is dialed, the panel will send the account number and Reporting Code followed by the [#] key (Hex [C]).

The panel has no way of confirming if the pager was called successfully; a Failure To Communicate trouble will thus never be generated.

! *The Pager Format cannot be used with the LINKS 1000 cellular communicator.*

! *It is recommended not to use the digit C in a reporting code when using Pager Format. In most cases, the digit C will be interpreted as a [#], which will terminate the page before it has finished.*

! *Pager Format will not force dial, but will check for busy tone regardless of the busy tone detect option.*

5.9 Downloading

Downloading allows you to program the entire control panel via a computer, a modem and a telephone line. All functions and features and their changes and status – such as trouble conditions and open zones – can be viewed or programmed through downloading.

! *When power is applied to the panel, downloading will be enabled for six hours. This will allow you to perform downloading without having to do any keypad programming.*

If the **Downloading Answer** option is enabled, or during the first six hours after power up, the panel will answer calls for downloading when the programmed **Number of Rings** is heard by the panel.

If the **Answering Machine Override** option is enabled (or during the first six hours after power up), the panel will answer incoming calls for downloading in the following manner:

1. The panel hears one or two rings then misses a ring.
2. At this point the panel will start a timer.
3. If the panel hears another ring before the **Answering Machine Double-Call Timer** expires, it will answer on the first ring of the second call.

The panel will immediately go on line and begin downloading. If the **Call-Back** option is enabled, the panel and the computer will both hang up. The panel will then call the **Downloading Computer's Telephone Number** and wait for the computer to answer. Once the computer answers, downloading will begin.

If the **User Enabled DLS Window for One Hour** option is ON, the user can activate the downloading feature for one hour by entering [*] [6] [Master Code] [5]. After one hour, the panel will not answer incoming calls unless the **Downloading Answer** option is enabled.

The **Download Access Code** and **Panel Identifier Code** are for security and proper identification. Both the panel and the computer file should contain the same information programmed before attempting to download.

The time to complete a successful download can be significantly reduced with the use of the PC-LINK. This adaptor will allow on-site downloading of supported panels to occur. To **Initiate Local Downloading via the PC-LINK**, enter [*] [8] [Installer's Code] [77] [Installer's Code] [77].

Downloading can also be performed through the LINKS 1000 cellular communicator if the phone line is disconnected. If Call Back is being used, you may have to program the **LINKS 1000 Preamble** to have the panel call the computer correctly.

! *When a Zone Status Upload is performed through PC-Link, the information uploaded may not be accurate. For more information refer to the Download Manual included with the computer software.*

.....

Downloading Answer Section [71], Option [1]
Number of Rings Section [70]
Answering Machine Override..... Section [71], Option [6]
User Enable DLS Window for One Hour Section [71], Option [2]
Call-Back Section [71], Option [3]
Answering Machine Double Call Timer Section [75]
Download Computer Telephone Number..... Section [72]
Download Access Code Section [73]
Panel Identification Code Section [74]
Initiate Local Downloading (PC-LINK) Section [77]
LINKS 1000 Preamble (Downloading)..... Section [79]

5.10 Telephone Line Monitor (TLM)

The panel will supervise the presence of the phone line and will indicate a trouble condition if the phone line is disconnected. If the **TLM Enabled** option is selected, the panel will wait for the **TLM Trouble Delay** time period before indicating the trouble so that a momentary interruption of the phone line will not cause a trouble condition.

If the **TLM Trouble Only** option is enabled, the panel will indicate a TLM trouble only at the keypad if the system is armed. To activate the bell output in the case of a TLM trouble while the system is armed, the **Audible When Armed** option must be selected.

When the trouble condition is restored, the panel can send a **TLM Restoral** Reporting Code. Any events which occur while the phone line is down will also be communicated.

If the LINKS 1000 Cellular Communicator is being used, the panel can be programmed to report a **TLM Trouble Reporting Code**.

.....

TLM Enable/Disable Section [08], Option [5]
TLM Trouble Only or Audible When Armed Section [08], Option [6]
TLM Trouble Reporting Code Section [43]
TLM Restoral Reporting Code Section [44]
TLM Trouble Delay Section [62], Option [1]

5.11 Siren Supervision

The panel supervises the Bell output. If an open condition is detected or if the fuse is blown, the panel will immediately indicate a trouble condition by beeping the keypad twice every 10 seconds to alert the owner of the problem. The panel can send a **Bell Circuit Trouble** Reporting Code immediately. Once the problem is corrected, the panel can send a **Bell Circuit Trouble Restoral** Reporting Code.

.....

Bell Circuit Trouble Reporting Code Section [43]
Bell Circuit Trouble Restoral Reporting Code Section [44]

5.12 Test Transmission

To ensure that the communication link with the central station is functioning properly, the panel can be programmed to send a test transmission signal on a regular basis.

The panel can send a **Periodic Test Transmission Reporting Code** at the programmed **Test Transmission Time of Day**. The **Test Transmission Cycle** determines the number of days (001 to 255) between tests. If the test transmission cycle being programmed is of a lesser value than the previous value, the system will wait the original period before the next test transmission is sent, and then begin reporting with the new interval.

The panel can also send a test for the LINKS 1000 Cellular Communicator, if being used. If the **LINKS 1000 Test Transmission Code** is programmed, the panel will send a cellular test at the same time as the land line test transmission.

The end user can generate a communicator test. If the **System Test Reporting Code** is programmed, the panel will send the signal when the System Test keypad command is entered (see Section 3.4 - "[*] Commands; [*] [6] User Functions").

.....
Periodic Test Transmission Reporting Code.. Section [46]
Test Transmission Time of Day Section [63]
Test Transmission Cycle..... Section [62]
LINKS 1000 Test Transmission Reporting Code Section [46]
System Test Reporting Code Section [46]

5.13 Fire, Auxiliary and Panic Keys – [F], [A], [P]

The emergency keys are available on all keypads. These keys must be pressed and held for two seconds before they will activate. This two second delay is designed to help prevent accidental activation.

 If the **[F] Key** option is enabled, when the Fire keys are pressed and held for two seconds, the panel will activate the alarm output, pulsing one second ON, one second OFF. The alarm output will sound until a code is entered or until the alarm output times out. Communication of the signal to central station is immediate.

 If the **[A] Key** is pressed and held for two seconds, the panel will sound the keypad beeper three times to verify activation. The panel will beep the keypad ten times rapidly to verify communication to the central station.

 If the **[P] Key** is pressed and held for two seconds, the panel will immediately communicate the signal to central station. If **[P] Key Audible Bell and Buzzer** option is enabled, the panel will beep the keypad three times upon activation and activate the alarm output until a code is entered or the alarm output times out. Otherwise the alarm will be completely silent.

 **The Fire, Auxiliary, Panic keys will operate even if Keypad Blanking is active (See Section 5.20 “Keypad Blanking”).**

.....
[F] Key Enable..... Section [08], Option [3]
[P] Key Audible Bell and Buzzer.. Section [08], Option [4]

5.14 Arming/Disarming Options

If the **Quick Arm** option is enabled, the panel can be armed without a user code by entering [*] [0] or by pressing the Stay or Away key on the LCD5500 or PC5506 keypads.

The **Quick Exit** option, if enabled, will allow someone to leave an armed premises through a Delay type zone without having to disarm and rearm the system.

If the **Arm/Disarm Bell Squawk** option is enabled, the panel will squawk the alarm output once upon arming and twice upon disarming. The **Opening After Alarm Keypad Ringback** option will give you the ability to beep the keypad 10 times rapidly if the panel is disarmed after an alarm occurred. The **Opening After Alarm Bell Squawk** option will give you the ability to squawk the bell output 10 times rapidly if the panel is disarmed after an alarm occurred.

Closing Confirmation, if enabled, will cause the keypad to beep 10 times rapidly after the closing Reporting Code has been transmitted to central station.

If the **Bypass Status Displayed While Armed** is chosen, the Bypass light will be ON while the system is armed to indicate any bypassed zones.

.....
Quick Arm Enable Section [10], Option [6]
Quick Exit Enable Section [09], Option [4]
Arm/Disarm Bell Squawk..... Section [10], Option [1]
Closing Confirmation Section [61], Option [1]
Opening After Alarm Keypad Ringback . Section [61], Option [2]
Opening After Alarm Bell Ringback . Section [61], Option [3]
Bypass Status Displayed While Armed . Section [09], Option [5]

 **With Arm/Disarm Bell Squawk enabled, when a [*][9] arming is performed, no squawk will sound.**

5.15 Entry/Exit Delay Options

Upon arming, the panel will begin the exit delay. If the **Audible Exit Delay with Urgency** option is enabled, the keypad will beep at one second intervals until the exit delay expires. The keypad will beep rapidly for the last 10 seconds of exit delay to warn the user that the system is about to arm.

For commercial applications, the **Bell Squawk on Exit Delay** option may be enabled. The panel will squawk the alarm output once every second when the exit delay is initiated and three times per second for the last 10 seconds until the exit delay expires.

Upon entry, if a Delay type zone is violated, the panel will begin the entry delay. The keypad will emit a steady tone. The keypad will pulse the keypad sounder during the last 10 seconds to warn the user the system is about to go into alarm. If there was an alarm during the armed period, the keypad will pulse for the entire entry delay to warn the user of the previous alarm.

For commercial applications **Bell Squawk on Entry Delay** may be enabled. The panel will squawk the alarm output once every second until the entry delay expires or the system is disarmed.

 **Since two Delay zones – and therefore two different Entry Delays – are programmable, when the panel is armed, the Entry Delay will begin when the first delay zone violated.**

If the **Bell Squawk During Auto Arm** option is enabled, the bell will squawk when the system is auto-armed in order to notify anyone on the premises that the system is being armed.

If the **Exit Delay Termination** option is enabled, the panel will monitor the Delay zones during exit delay. During the exit delay, if a Delay type zone is violated and then secured, the exit delay will be terminated and the panel will be armed immediately.

.....
Entry Delay 1 and 2 (System Times) Section [02]
Exit Delay (System Times)..... Section [02]
Bell Squawk Options..... Section [10]
Audible Exit Delay Section [10], Option [5]
Exit Delay Termination Section [11], Option [4]

5.16 Swinger Shutdown

The Swinger Shutdown feature is designed to prevent a runaway communicator from tying up the central station. After the panel has communicated the programmed number of transmissions for an event, it will no longer report that event until the Swinger Shutdown is reset.

By default, the **Swinger Shutdown** limit is set to [003]. The panel will not send more than three alarm signals for each zone until the Swinger Shutdown is reset.

Swinger Shutdown will be reset every day at midnight or when the panel is armed. Once reset, the panel will again communicate normally.

.....
Swinger Shutdown Section [62]
.....

5.17 Transmission Delay

! *If Transmission Delay is being used, the Opening After Alarm code must be programmed. See section 5.7 "Communicator Reporting Codes".*

New customers often cause false alarms while becoming familiar with the system. The Transmission Delay is designed to delay the communication of a zone alarm for a programmed period of time. If the system is disarmed before the transmission delay time expires, the panel will not report the alarm to the central station. The Opening After Alarm code, however, will still be communicated to the central station. By default, the Transmission Delay is not programmed.

.....
Transmission Delay Section [62]
.....

5.18 Event Buffer

The panel will store the last 100 events which occurred on the system. The Event Buffer will contain the name, time and date of each event, along with the zone number, user code number or any other information pertaining to the event.

If the **Event Buffer Follows Swinger Shutdown** option is enabled, the Event Buffer will not store events after the Swinger Shutdown level has been reached. This will prevent the panel from overwriting the entire buffer if a problem exists.

The Event Buffer can be viewed in three different ways: from an LCD keypad (see Section 3.4 – [★] [6] "User Functions"), printed on-site using the PC5400 printer module (see Section 5.24 – "On-Site Printer") or it can be uploaded using DLS software.

.....
Event Buffer Follows Swinger Shutdown Section [11], Option [2]
.....

5.19 Keypad Lockout

The panel can be programmed to "lock out" keypads if a series of incorrect user codes are entered. Once the **Number of Invalid Codes Before Lockout** limit has been reached, the panel will lock out the keypad for the **Lockout Duration** and log the event to the Event Buffer. For the duration of the Lockout, the panel will sound an error tone when any key is pressed.

! *Keypad Lockout will reset every hour.*

To disable the keypad lockout option, program the **Number of Invalid Codes Before Lockout** as [00].

.....
Number of Invalid Codes Before Lockout Section [07]
Lockout Duration Section [07]
.....

5.20 Keypad Blanking

If the **Keypad Blanking** option is enabled, the panel will turn off all lights on the keypads when no keys are pressed for 30 seconds. The keys, however, will remain backlit.

The panel will turn the lights back on when any key is pressed or when the entry delay begins or if an audible alarm occurs.

.....
Keypad Blanking Option Section [11], Option [5]
.....

5.21 Loop Response

The normal loop response time for all zones is 500 milliseconds. The panel will not consider a zone violated unless it is violated for at least 500 milliseconds.

5.22 Keypad Tamper

If the **Keypad Tamper Enable** option is selected, the panel will display and transmit a **General System Tamper Reporting Code** if any keypad is removed from the wall. When the keypad tamper is restored, the panel will transmit the **General System Tamper Restoral Reporting Code**. All keypads should be properly installed and secured before enabling this option.

.....
Keypad Tamper Enable Section [11], Option [6]
General System Tamper Reporting Code Section [38]
General System Tamper Restoral Reporting Code Section [39]
.....

! *After enabling Keypad Tamper, it is recommended to tamper and restore all keypads to ensure proper functionality.*
If Keypad Tamper are disabled and Keypad Tamper had previously been indicated, the panel must be powered down to clear the trouble.

5.23 LINKS 1000 Cellular Communicator

The LINKS 1000 Cellular Communicator can be used three different ways: as the sole communicator for the panel, as a back up for either or both phone numbers or as a redundant back up to the land line communicator, where the panel will call both the land line and via the LINKS. A **LINKS Preamble** is programmable for each phone number in the event that the land line number is local but the LINKS is required to dial an exchange. When programming a LINKS Preamble, all unused digits must be programmed with a hexadecimal "F".

5.23.1 Using LINKS 1000 as the Sole Communicator

The panel can be programmed to report an event only using the LINKS 1000 cellular communicator. To program this option, select only the LINKS 1000 in the **Communicator Call Direction** Options. The **Call LINKS** as well as **Land Line** option must also be enabled.

When the selected event occurs the panel will only attempt to call central station using the LINKS.

5.23.2 Using the LINKS 1000 as a Backup Communicator

The panel can be programmed to call using the LINKS 1000 Cellular Communicator if the panel is having difficulty communicating an event using the land line. To program this option, select both the phone number and LINKS options in the **Communicator Call Direction** Options. The

LINKS is Backup of Land Lines option must be selected. When used as a backup communicator, the panel will attempt to call the central station in the following manner:

- the panel will try to call using land lines – if unsuccessful, the panel will try to call using the LINKS
- if unsuccessful, the panel will try to call using the land lines
- if unsuccessful, the panel will try to call using the LINKS

This process will continue until the panel has successfully communicated with the central station or until the panel's eight dialing attempts have been exhausted.

5.23.3 Using the LINKS as a Redundant Communicator

The panel can be programmed to call using first the land line and then the LINKS 1000 Cellular Communicator when an event occurs. To program this option, select both the phone number and the LINKS options for the **Communicator Call Direction** Options for the event. The **Call LINKS** as well as **Land Line** options must be selected.

- **LINKS Preamble (First Telephone Number)** Section [67], Option [5]
- **LINKS Preamble (Second Telephone Number)** Section [68]
- **LINKS Preamble (Third Telephone Number)** .. Section [69]
- **LINKS Preamble (Downloading Telephone Number)** Section [79]
- **Communicator Call Direction Options** Section [51] to [55]
- **Call LINKS as well as Land Line**” Section [61], Option [5]

5.24 On-Site Printer

With the addition of the PC5400 printer module, the panel will print all events as they occur to a local, on-site serial printer. All events will include the time and date when they occurred. If a problem develops with the printer – such as power loss or a paper shortage – the panel will store events in the Event Buffer and print the events once the problem is corrected. The panel can store up to 100 events if such a condition occurs.

- **PC5400 Programming** Section [87]

5.25 Downlook Video Transmission Module

The **Number of Pictures** the DLM Module will take is programmable from one to eight.

The **Delay Before Capture Timer** allows the programmer to delay the camera in taking a picture once a zone is tripped in order to make sure that the intruder steps into the camera's field of view. This timer is programmed in increments of 100 milliseconds from 00 to 99.

For more information regarding the operation of the DLM-1 and DLM-4 Modules, please refer to their respective installation manuals.

- **DLM-1/DLM-4 Support Timers (Downlook Modules)** Section [88]

! Downlook will only transmit to phone number 1. Downlook and Tx Delay must not be enabled at the same time.

! A valid zone alarm reporting code must be programmed for zones that have Downlook enabled.

5.26 Resetting Factory Defaults

On occasion, it may be necessary to default the main control panel or one of the connected modules: the ESCORT5580 module and the PC5400 Printer module.

To default the main control panel (hardware) perform the following:

1. Remove AC and battery from the panel.
2. Remove all wires from the Zone 1 and PGM1 terminals.
3. With a piece of wire short the Zone 1 terminal to the PGM1 terminal.
4. Apply AC power to the main panel.
5. When Zone Light 1 is lit on the keypad the default is complete.
6. Remove AC power from the control
7. Reconnect all original wiring and power up the control.

! AC power must be used to power the panel. The panel will not default if the battery is used.

To default the main control panel software and other modules, perform the following:

1. Enter the Installer's Programming mode.
 2. Enter the appropriate programming section [XY].
 3. Enter the Installer's Code.
 4. Re-enter the appropriate programming section [XY].
- The panel will take a few seconds to perform the default. When the keypad is again operational the default is complete.

- **Restore ESCORT to Factory Default Programming** Section [95]
- **Restore PC5400 to Factory Default Programming** Section [97]
- **Restore Panel to Factory Default Programming** .. Section [99]

5.27 Installer's Lockout

If **Installer's Lockout** is selected, a hardware default cannot be performed. If a software default is performed, all programming will restore to factory default.

If **Installer's Lockout Disable** is selected, the panel will restore all programming to factory defaults when a hardware or software default is performed on the main control panel.

To enable or disable Installer's Lockout, perform the following:

1. Enter the Installer's Programming mode.
2. Enter the appropriate programming section [XY].
3. Enter the Installer's Code.
4. Re-enter the appropriate programming section [XY].

- **Installer Lockout Enable** Section [90]
- **Installer Lockout Disable** Section [91]

Programming Worksheets

NOTE: For UL listed systems, refer to the UL Requirements section in Appendix E.

For the Record

Customer: _____

Address: _____

Phone: _____ Installation Date: _____

Installer's Code: _____

Module Name	Description	Physical Location
PC1575	Main Panel	_____
PC5400*	Serial Printer Module	_____
Escort 5580*	Voice Prompt Module	_____
DLM-1/DLM-4*	Downlook Module	_____

*** Not UL Listed**

Keypads	Keypad Type	Physical Location
Keypad 1	_____	_____
Keypad 2	_____	_____
Keypad 3	_____	_____
Keypad 4	_____	_____
Keypad 5	_____	_____
Keypad 6	_____	_____
Keypad 7	_____	_____
Keypad 8	_____	_____

PC1575 Zone 1 to 6 Assignment

System Zone	Zone Label	Zone Type	Attributes												
			AUDIBLE	STEADY	CHIME	FORCE ARM	BYPASS	DOWN-LOOK							
Zone 1															
Zone 2															
Zone 3															
Zone 4															
Zone 5															
Zone 6															

Keypad Programming

PROGRAMMING WORKSHEETS

[00] Keypad Assignment *(Section 2.6 "Keypad Assignment")*

Note: This must be done at each keypad requiring programming.

[0] Slot (Valid entries are 11-18 for the Slot)

[1] - [5] Function Keys 1 to 5 Assignment (Valid entries are 00-18)

- | | | |
|---------------------------------|------------------------------------|---|
| 00 Null Key (Not Used) | 07 [★][6][—][4] System Test | 13 [★][7][1] Utility Output |
| 01 Not used | 08 [★][1] Bypass Mode | 14 [★][7][2] Sensor Reset |
| 02 Not used | 09 [★][2] Trouble Display | 15 Not Used |
| 03 Stay Arm | 10 [★][3] Alarm Memory | 16 [★][0] Quick Exit |
| 04 Away Arm | 11 [★][5] User Programming | 17 [★][1] Reactivate Stay/Away's |
| 05 [★][9] No-Entry Arm | 12 [★][6] User Functions | 18 Not Used |
| 06 [★][4] Chime On / Off | | |

	Slot (Address)	Function Key 1	Function Key 2	Function Key 3	Function Key 4	Function Key 5
1575RK defaults	11	-	-	-	-	-
PC5506 defaults	11	03	04	06	14	16
LCD5500 defaults	18	03	04	06	14	16
KEYPAD 1	_____	_____	_____	_____	_____	_____
KEYPAD 2	_____	_____	_____	_____	_____	_____
KEYPAD 3	_____	_____	_____	_____	_____	_____
KEYPAD 4	_____	_____	_____	_____	_____	_____
KEYPAD 5	_____	_____	_____	_____	_____	_____
KEYPAD 6	_____	_____	_____	_____	_____	_____
KEYPAD 7	_____	_____	_____	_____	_____	_____
KEYPAD 8	_____	_____	_____	_____	_____	_____

Basic System Programming

PROGRAMMING WORKSHEETS

Zone Definitions

- | | | |
|--------------------------------|---------------------------------------|-----------------------------------|
| 00 Null Zone (Not Used) | 08 Standard 24 Hour Fire | 15 24 Hour Auxiliary |
| 01 Delay 1 | 09 24 Hour Supervisory (LINKS) | 16 24 Hour Panic |
| 02 Delay 2 | 10 24 Hour Supervisory Buzzer | 17 24 Hour Emergency |
| 03 Instant | 11 24 Hour Burglary | 18 24 Hour Sprinkler |
| 04 Interior | 12 24 Hour Heat | 19 24 Hour Water |
| 05 Interior, Stay/Away | 13 <i>not used</i> | 20 24 Hour Freeze |
| 06 Delay, Stay/Away | 14 24 Hour Hold-up | 21 24 Hour Latching Tamper |
| 07 Delayed 24 Hour Fire | | |

[01] Zone 1-6 Definitions *(Section 5.2 "Zone Definitions")*

Default	Default
01 _____ Zone 1	03 _____ Zone 4
06 _____ Zone 2	03 _____ Zone 5
03 _____ Zone 3	03 _____ Zone 6

[02] System Times

Default [000-255]	
030 _____	Entry Delay 1
045 _____	Entry Delay 2
120 _____	Exit Delay
004 _____	Bell Cutoff

[03] Installer's Code (Section 4 "How to Program")

Default
1575

[04] Master Code (Section 5.1 "Programming Security Codes")

Default
1234

[05] Second Master Code (Section 5.1 "Programming Security Codes")

Default
AAAA

Programmable Output Options

! Please refer to Appendix D "PGM Output Options" for output descriptions and important information.

- | | |
|--|--|
| 01 Ground Start Pulse | 13 20 Minute Latched Alarm |
| 02 Utility Output with Any Access Code
([*] [7] [1] + [Access Code]) | 14 Line Seizure |
| 03 Sensor Reset ([*] [7] [2]) | 15 Ready to Arm Status |
| 04 Courtesy Pulse | 16 LINKS Support (PGM 1 Only) |
| 05 Keypad Buzzer Follower Mode | 17 Downlook Support (PGM1 and PGM2 must be
programmed with 17) |
| 06 System Armed Status | 25 2-Wire Smoke Support (PC1575 2-wire smoke option PGM2 Only) |
| 07 Strobe Output | 26 Momentary Key Switch Arm (PGM2 Only) |
| 08 Fail to Communicate / TLM Trouble Output | 27 Maintained Key Switch Arm (PGM2 Only) |
| 09 Entry Delay Follower | 28 Silent 24 Hour (PGM2 Only) |
| 10 Exit Delay Follower | 29 Audible 24 Hour (PGM2 Only) |
| 11 TLM and Alarm | 30 Forced Answer (PGM2 Only) |
| 12 Police Code Follower | |

[06] Programmable Terminals PGM 1 and 2 (Appendix D "PGM Output Options")

Default		Default	
02	<input type="text"/> <input type="text"/>	PGM1	08 <input type="text"/> <input type="text"/> PGM2

[07] Keypad Lockout Options (Section 5.19 "Keypad Lockout")

Default		
00	<input type="text"/> <input type="text"/>	Number of Invalid Codes Before Lockout
00	<input type="text"/> <input type="text"/>	Lockout Duration (in minutes)

[08] First System Option Code

Default	Option	ON	OFF	Section
OFF	<input type="checkbox"/>	1 Normally Closed Loops	End-of-Line Resistors	2.8
OFF	<input type="checkbox"/>	2 Double End-of-Line Resistors	Single End-of-Line Resistors	2.8
ON	<input type="checkbox"/>	3 [F] Key Enabled	[F] Key Disabled	5.13
OFF	<input type="checkbox"/>	4 [P] Key Audible Bell and Buzzer	[P] Key Silent Bell and Buzzer	5.13
ON	<input type="checkbox"/>	5 TLM Enabled	TLM Disabled	5.10
OFF	<input type="checkbox"/>	6 TLM Audible When Armed	TLM Trouble Only When Armed	5.10

[09] Second System Option Code

Default	Option	ON	OFF	Section
OFF	<input type="checkbox"/>	1 Master Code Not Changeable	Master Code Changeable	5.1
OFF	<input type="checkbox"/>	2 Code Required For Bypassing	No Code Required	5.1
OFF	<input type="checkbox"/>	3 6th Code is Duress Code	6th Code is Normal Code	5.1
OFF	<input type="checkbox"/>	4 Quick Exit Enabled	Quick Exit Disabled	3.4
OFF	<input type="checkbox"/>	5 Bypass Status Displayed While Armed	Bypass Status Not Displayed While Armed	3.4
ON	<input type="checkbox"/>	6 AC Trouble Displayed	AC Trouble Not Displayed	3.4

[10] Third System Option Code

Default	Option	ON	OFF	Section
OFF	<input type="checkbox"/>	1 Arm / Disarm Bell Squawk Enabled	Arm / Disarm Bell Squawk Disabled	5.14
OFF	<input type="checkbox"/>	2 Bell Squawk During Auto Arm	No Bell Squawk During Auto Arm	5.15
OFF	<input type="checkbox"/>	3 Bell Squawk On Exit Delay	No Bell Squawk On Exit Delay	5.15
OFF	<input type="checkbox"/>	4 Bell Squawk On Entry Delay	No Bell Squawk On Entry Delay	5.15
ON	<input type="checkbox"/>	5 Audible Exit With Urgency	Silent Exit Delay	5.15
ON	<input type="checkbox"/>	6 Quick Arm Enabled	Quick Arm Disabled	3.4

[11] Fourth System Option Code

Default	Option	ON	OFF	Section
OFF	<input type="checkbox"/>	1 For Future Use		
ON	<input type="checkbox"/>	2 Event Buffer Follow Swinger Shutdown	Event Buffer Never Shuts Down	5.18
ON	<input type="checkbox"/>	3 Trouble Light Flashes If AC Fails	Trouble Light Does Not Flash If AC Fails	3.4
OFF	<input type="checkbox"/>	4 Exit Delay Termination Enabled	Exit Delay Termination Disabled	5.15
OFF	<input type="checkbox"/>	5 Keypad Blanking Enabled	Keypad Blanking Disabled	5.20
OFF	<input type="checkbox"/>	6 Keypad Tamper Enabled	Keypad Tamper Disabled	5.22

Advanced System Programming

PROGRAMMING WORKSHEETS

Zone Attribute Defaults

	00	01	02	03	04	05	06	07	08	09	10	11	12	14	15	16	17	18	19	20	21	
Option 1 – Audible / Silent	N	Y	Y	Y	Y	Y	Y	Y	Y	N	N	Y	Y	N	Y	Y	Y	Y	Y	Y	Y	Y
Option 2 – Steady / Pulsed	N	Y	Y	Y	Y	Y	Y	N	N	Y	Y	Y	N	Y	Y	Y	Y	Y	Y	Y	Y	Y
Option 3 – Chime	N	Y	Y	Y	N	N	N	N	N	N	N	N	N	N	N	N	N	N	N	N	N	N
Option 4 – Force	N	N	N	N	N	Y	Y	N	N	Y	N	N	N	N	N	N	N	N	N	N	N	N
Option 5 – Bypass	N	Y	Y	Y	Y	Y	Y	N	N	N	Y	Y	N	N	N	N	N	N	N	N	N	N
Option 6 – Downlook	N	N	N	N	N	N	N	N	N	N	N	N	N	N	N	N	N	N	N	N	N	N

	00	01	02	03	04	05	06	07	08	09	10	11	12	14	15	16	17	18	19	20	21
Null Zone (Not Used)																					
Delay 1																					
Delay 2																					
Instant																					
Interior																					
Interior, Stay/Away																					
Delay, Stay/Away																					
Delayed 24hr Fire																					
Standard 24hr Fire																					
24hr Supervisory (LINKS)																					
24hr Supervisory Buzzer																					
24hr Burglary																					
24hr Heat																					
24hr Hold-up																					
24hr Auxiliary																					
24hr Panic																					
24hr Emergency																					
24hr Sprinkler																					
24hr Water																					
24hr Freeze																					
24hr Latching Tamper																					

Y = Option ON **N = Option OFF**

Zone 1-6 Attributes (Section 5.3 "Zone Attributes")

	On	Opt. 1	Opt. 2	Opt. 3	Opt. 4	Opt. 5	Opt. 6
	Off	Audible	Steady	Chime	Force	Bypass	Downlook
		Silent	Pulsed	No	No	No	No
[21] Zone 1	<input type="checkbox"/>	<input type="checkbox"/>	<input type="checkbox"/>	<input type="checkbox"/>	<input type="checkbox"/>	<input type="checkbox"/>	<input type="checkbox"/>
[22] Zone 2	<input type="checkbox"/>	<input type="checkbox"/>	<input type="checkbox"/>	<input type="checkbox"/>	<input type="checkbox"/>	<input type="checkbox"/>	<input type="checkbox"/>
[23] Zone 3	<input type="checkbox"/>	<input type="checkbox"/>	<input type="checkbox"/>	<input type="checkbox"/>	<input type="checkbox"/>	<input type="checkbox"/>	<input type="checkbox"/>
[24] Zone 4	<input type="checkbox"/>	<input type="checkbox"/>	<input type="checkbox"/>	<input type="checkbox"/>	<input type="checkbox"/>	<input type="checkbox"/>	<input type="checkbox"/>
[25] Zone 5	<input type="checkbox"/>	<input type="checkbox"/>	<input type="checkbox"/>	<input type="checkbox"/>	<input type="checkbox"/>	<input type="checkbox"/>	<input type="checkbox"/>
[26] Zone 6	<input type="checkbox"/>	<input type="checkbox"/>	<input type="checkbox"/>	<input type="checkbox"/>	<input type="checkbox"/>	<input type="checkbox"/>	<input type="checkbox"/>

Communicator Programming

PROGRAMMING WORKSHEETS

Note: For sections [31] to [46], the contents of every section by default is [F].

[31] First Telephone Number (32 Digits) *(Section 5.6 "Communicator – Phone Numbers")*

[32] Second Telephone Number (32 Digits) *(Section 5.6 "Communicator – Phone Numbers")*

[33] Third Telephone Number (32 Digits) *(Section 5.6 "Communicator – Phone Numbers")*

[34] First Account Code (4 digits) *(Section 5.5 "Communicator – Account Numbers")*

[35] Second Account Code (4 digits) *(Section 5.5 "Communicator – Account Numbers")*

[36] Alarm Reporting Codes, Zones 1-6 *(Section 5.7 "Communicator – Reporting Codes")*

_____ Zone 1	_____ Zone 4	_____ Police Code Alarm
_____ Zone 2	_____ Zone 5	
_____ Zone 3	_____ Zone 6	

[37] Alarm Restoral Reporting Codes, Zones 1-6 *(Section 5.7 "Communicator – Reporting Codes")*

_____ Zone 1	_____ Zone 4	_____ Opening After Alarm
_____ Zone 2	_____ Zone 5	
_____ Zone 3	_____ Zone 6	

[38] Tamper Reporting Codes, Zones 1-6 *(Section 5.7 "Communicator – Reporting Codes")*

_____ Zone 1	_____ Zone 4	_____ General System
_____ Zone 2	_____ Zone 5	_____ Tamper Alarm
_____ Zone 3	_____ Zone 6	

[39] Tamper Restoral Reporting Codes, Zones 1-6 *(Section 5.7 "Communicator – Reporting Codes")*

_____ Zone 1	_____ Zone 4	_____ General System
_____ Zone 2	_____ Zone 5	_____ Tamper Restoral
_____ Zone 3	_____ Zone 6	

[40] Priority Alarm and Restoral Reporting Codes *(Section 5.7 "Communicator – Reporting Codes")*

_____ Keypad [F]ire Alarm	_____ PGM2 Alarm	_____ Keypad [A]uxiliary Restoral
_____ Keypad [A]uxiliary Alarm	_____ Duress Code Alarm	_____ Keypad [P]anic Restoral
_____ Keypad [P]anic Alarm	_____ Keypad [F]ire Restoral	_____ PGM2 Restoral

[41] Closing (Arming) Reporting Codes, Access Codes 1-6 *(Section 5.7 "Communicator – Reporting Codes")*

_____ Closing by Access Code 1 / 2nd Master / Key switch / Auto Arm	
_____ Closing by Access Code 2	_____ Closing by Access Code 5
_____ Closing by Access Code 3	_____ Closing by Access Code 6
_____ Closing by Access Code 4	_____ Partial Closing Code

[42] Opening (Disarming) Reporting Codes, Access Codes 1-6 (*Section 5.7 "Communicator – Reporting Codes"*)

- | | | | |
|---|--|---|--------------------------|
| <input type="checkbox"/> <input type="checkbox"/> <input type="checkbox"/> <input type="checkbox"/> | Opening by Access Code 1 / 2nd Master / Key switch | | |
| <input type="checkbox"/> <input type="checkbox"/> <input type="checkbox"/> <input type="checkbox"/> | Opening by Access Code 2 | <input type="checkbox"/> <input type="checkbox"/> <input type="checkbox"/> <input type="checkbox"/> | Opening by Access Code 5 |
| <input type="checkbox"/> <input type="checkbox"/> <input type="checkbox"/> <input type="checkbox"/> | Opening by Access Code 3 | <input type="checkbox"/> <input type="checkbox"/> <input type="checkbox"/> <input type="checkbox"/> | Opening by Access Code 6 |
| <input type="checkbox"/> <input type="checkbox"/> <input type="checkbox"/> <input type="checkbox"/> | Opening by Access Code 4 | | |

[43] Miscellaneous Closing (Arming) Reporting Codes (*Section 5.7 "Communicator – Reporting Codes"*)

- | | | | |
|---|----------------------------|---|------------------------------|
| <input type="checkbox"/> <input type="checkbox"/> <input type="checkbox"/> <input type="checkbox"/> | Battery Trouble Alarm | <input type="checkbox"/> <input type="checkbox"/> <input type="checkbox"/> <input type="checkbox"/> | AUX Fuse Failure Alarm |
| <input type="checkbox"/> <input type="checkbox"/> <input type="checkbox"/> <input type="checkbox"/> | AC Failure Trouble Alarm | <input type="checkbox"/> <input type="checkbox"/> <input type="checkbox"/> <input type="checkbox"/> | TLM Trouble Code (via LINKS) |
| <input type="checkbox"/> <input type="checkbox"/> <input type="checkbox"/> <input type="checkbox"/> | Bell Circuit Trouble Alarm | <input type="checkbox"/> <input type="checkbox"/> <input type="checkbox"/> <input type="checkbox"/> | General System Supervisory |
| <input type="checkbox"/> <input type="checkbox"/> <input type="checkbox"/> <input type="checkbox"/> | Fire Trouble Alarm | | |

[44] Maintenance Restoral Reporting Codes (*Section 5.7 "Communicator – Reporting Codes"*)

- | | | | |
|---|-------------------------------|---|-------------------------------------|
| <input type="checkbox"/> <input type="checkbox"/> <input type="checkbox"/> <input type="checkbox"/> | Battery Trouble Restoral | <input type="checkbox"/> <input type="checkbox"/> <input type="checkbox"/> <input type="checkbox"/> | AUX Fuse Trouble Restoral |
| <input type="checkbox"/> <input type="checkbox"/> <input type="checkbox"/> <input type="checkbox"/> | AC Failure Trouble Restoral | <input type="checkbox"/> <input type="checkbox"/> <input type="checkbox"/> <input type="checkbox"/> | TLM Restoral |
| <input type="checkbox"/> <input type="checkbox"/> <input type="checkbox"/> <input type="checkbox"/> | Bell Circuit Trouble Restoral | <input type="checkbox"/> <input type="checkbox"/> <input type="checkbox"/> <input type="checkbox"/> | General System Supervisory Restoral |
| <input type="checkbox"/> <input type="checkbox"/> <input type="checkbox"/> <input type="checkbox"/> | Fire Trouble Restoral | | |

[45] Miscellaneous Maintenance Reporting Codes (*Section 5.7 "Communicator – Reporting Codes"*)

- | | | | |
|---|--|---|-----------------------------|
| <input type="checkbox"/> <input type="checkbox"/> <input type="checkbox"/> <input type="checkbox"/> | Phone Number 1 Failure to Communicate | <input type="checkbox"/> <input type="checkbox"/> <input type="checkbox"/> <input type="checkbox"/> | General Zone Fault Alarm |
| <input type="checkbox"/> <input type="checkbox"/> <input type="checkbox"/> <input type="checkbox"/> | Phone Number 2 Failure to Communicate | <input type="checkbox"/> <input type="checkbox"/> <input type="checkbox"/> <input type="checkbox"/> | General Zone Fault Restoral |
| <input type="checkbox"/> <input type="checkbox"/> <input type="checkbox"/> <input type="checkbox"/> | Event Buffer is 75% Full Since Last Upload | <input type="checkbox"/> <input type="checkbox"/> <input type="checkbox"/> <input type="checkbox"/> | Delinquency Reporting Code |

[46] Test Transmission Reporting Codes (*Section 5.7 "Communicator – Reporting Codes"*)

- | | |
|---|-----------------------------------|
| <input type="checkbox"/> <input type="checkbox"/> <input type="checkbox"/> <input type="checkbox"/> | Periodic Test Transmission |
| <input type="checkbox"/> <input type="checkbox"/> <input type="checkbox"/> <input type="checkbox"/> | System Test |
| <input type="checkbox"/> <input type="checkbox"/> <input type="checkbox"/> <input type="checkbox"/> | LINKS 1000 Test Transmission Code |

[50] Communicator Format Options (*Section 5.8 "Communicator – Reporting Formats"*)

- Default
- | | | | |
|----|---|---------------------------|-----------------|
| 02 | <input type="checkbox"/> <input type="checkbox"/> <input type="checkbox"/> <input type="checkbox"/> | 1st Phone Number | |
| 02 | <input type="checkbox"/> <input type="checkbox"/> <input type="checkbox"/> <input type="checkbox"/> | 2nd Phone Number | |
| 01 | | 20 BPS, 1400 HZ handshake | 04 SIA FSK |
| 02 | | 20 BPS, 2300 HZ handshake | 05 Pager Format |
| 03 | | DTMF CONTACT I.D. | |

[51] Zone Alarms & Restorals Communicator Call Directions (*Section 5.4 "Communicator – Dialing"*)

- | Default | | Option | ON | OFF |
|---------|---|----------|----------------------------------|----------|
| ON | <input type="checkbox"/> <input type="checkbox"/> | 1 | 1st Telephone Number | Disabled |
| OFF | <input type="checkbox"/> <input type="checkbox"/> | 2 | 2nd Telephone Number | Disabled |
| OFF | <input type="checkbox"/> <input type="checkbox"/> | 3 | 1st Telephone Number (via LINKS) | Disabled |
| OFF | <input type="checkbox"/> <input type="checkbox"/> | 4 | 2nd Telephone Number (via LINKS) | Disabled |

[52] Zone Tamper Alarms & Tamper Restorals Communicator Call Directions (*Section 5.4 "Communicator – Dialing"*)

- | Default | | Option | ON | OFF |
|---------|---|----------|----------------------------------|----------|
| ON | <input type="checkbox"/> <input type="checkbox"/> | 1 | 1st Telephone Number | Disabled |
| OFF | <input type="checkbox"/> <input type="checkbox"/> | 2 | 2nd Telephone Number | Disabled |
| OFF | <input type="checkbox"/> <input type="checkbox"/> | 3 | 1st Telephone Number (via LINKS) | Disabled |
| OFF | <input type="checkbox"/> <input type="checkbox"/> | 4 | 2nd Telephone Number (via LINKS) | Disabled |

[53] Openings & Closings Communicator Call Directions *(Section 5.4 "Communicator – Dialing")*

Default	Option	ON	OFF
ON	<input type="checkbox"/>	1 1st Telephone Number	Disabled
OFF	<input type="checkbox"/>	2 2nd Telephone Number	Disabled
OFF	<input type="checkbox"/>	3 1st Telephone Number (via LINKS)	Disabled
OFF	<input type="checkbox"/>	4 2nd Telephone Number (via LINKS)	Disabled

[54] System Maintenance Alarms & Restorals Communicator Call Directions *(Section 5.4 "Communicator – Dialing")*

Default	Option	ON	OFF
ON	<input type="checkbox"/>	1 1st Telephone Number	Disabled
OFF	<input type="checkbox"/>	2 2nd Telephone Number	Disabled
OFF	<input type="checkbox"/>	3 1st Telephone Number (via LINKS)	Disabled
OFF	<input type="checkbox"/>	4 2nd Telephone Number (via LINKS)	Disabled

[55] System Test Transmissions Communicator Call Directions *(Section 5.4 "Communicator – Dialing")*

Default	Option	ON	OFF
ON	<input type="checkbox"/>	1 1st Telephone Number (Periodic Test TX and System Test Only)	Disabled
OFF	<input type="checkbox"/>	2 2nd Telephone Number (Periodic Test TX and System Test Only)	Disabled
OFF	<input type="checkbox"/>	3 1st Telephone Number (via LINKS) (LINKS 1000 Test TX Code Only)	Disabled
OFF	<input type="checkbox"/>	4 2nd Telephone Number (via LINKS) (LINKS 1000 Test TX Code Only)	Disabled

[60] First Communicator Option Code

Default	Option	ON	OFF	Section
ON	<input type="checkbox"/>	1 Communications Enabled	Communications Disabled	5.4
ON	<input type="checkbox"/>	2 DTMF Dialing	Pulse Dialing	5.4
ON	<input type="checkbox"/>	3 Switch to Pulse Dialing on 5th Attempt	DTMF Dial For All 8 Attempts	5.4
OFF	<input type="checkbox"/>	4 3rd Phone Number Enabled	3rd Phone Number Disabled	5.6
OFF	<input type="checkbox"/>	5 Alternate Dial (1st and 3rd)	Call 1st Number, Backup to 3rd (if programmed)	5.6
OFF	<input type="checkbox"/>	6 Restorals on Bell Time-out	Restorals Follow Zones	5.7.2

[61] Second Communicator Option Code

Default	Option	ON	OFF	Section
OFF	<input type="checkbox"/>	1 Closing Confirmation Enabled	Closing Confirmation Disabled	5.7.3
OFF	<input type="checkbox"/>	2 Opening After Alarm Keypad Ringback Enabled	Open After Alarm Bell Ringback Disabled	5.7.4
OFF	<input type="checkbox"/>	3 Opening After Alarm Bell Ringback Enabled	Opening After Alarm Bell Ringback Disabled	5.7.4
OFF	<input type="checkbox"/>	4 Busy Tone Detection Enabled	Busy Tone Detection Disabled	5.4
OFF	<input type="checkbox"/>	5 Call LINKS As Well As Land Line	LINKS is Backup of Land Line(s)	
OFF	<input type="checkbox"/>	6 SIA Sends Programmed Rep. Codes	SIA Sends Automatic Rep. Codes	5.8.3

[62] Communication Variables

Default	Section
003 <input type="checkbox"/>	Swinger Shutdown (Alarms and Rest) (001-014 Transmissions, 000=disabled) 5.16
000 <input type="checkbox"/>	Transmission Delay (001-255 seconds) 5.17
030 <input type="checkbox"/>	AC Failure Communication Delay (001-255 minutes) 5.7.7
003 <input type="checkbox"/>	TLM Trouble Delay (No. of valid checks required - 000-255 x 10s) 5.10
030 <input type="checkbox"/>	Test Transmission Cycle (001-255 days) 5.12
030 <input type="checkbox"/>	Delinquency Transmission Delay (000-255 days) 5.7.9

[63] Test Transmission Time of Day *(Section 5.12 "Test Transmission")*

Default	
9999 <input type="checkbox"/>	(Valid entries are 0000-2359, 9999 to disable)

- [67] LINKS 1000 Preamble (First Telephone Number) *(Section 5.23 "LINKS 1000 Cellular Communicator")*
 Default
 FFFF (Program all unused digits with Hex F)
- [68] LINKS 1000 Preamble (Second Telephone Number) *(Section 5.23 "LINKS 1000 Cellular Communicator")*
 Default
 FFFF (Program all unused digits with Hex F)
- [69] LINKS 1000 Preamble (Third Telephone Number) *(Section 5.23 "LINKS 1000 Cellular Communicator")*
 Default
 FFFF (Program all unused digits with Hex F)

Downloading Programming

P R O G R A M M I N G W O R K S H E E T S

- [70] Number of Rings to Answer On *(Section 5.9 "Downloading")*
 Default
 1 2 (Valid entries are 00-99)
- [71] First Downloading Option Code *(Section 5.9 "Downloading")*

Default		Option	ON		OFF
OFF	<input type="checkbox"/>	1	Downloading Answer Enabled	Downloading Answer Disabled	
ON	<input type="checkbox"/>	2	User Can Enable DLS Window for One Hour	User Cannot Enable DLS Window	
OFF	<input type="checkbox"/>	3	Call-Back Enabled	Call-Back Disabled	
OFF	<input type="checkbox"/>	4	User Initiated Call-up Enabled	User Initiated Call-up Disabled	
OFF	<input type="checkbox"/>	5	Periodic Download at Test TX Time	No Periodic Download	
OFF	<input type="checkbox"/>	6	Answering Machine Override Enabled	Answering Machine Override Disabled	
- [72] Downloading Computer's Telephone Number (32 Digits) *(Section 5.9 "Downloading")*
- [73] Downloading Access Code *(Section 5.9 "Downloading")*
 Default
 1575 Enter 4 Hexadecimal Digits
- [74] Panel Identification Code *(Section 5.9 "Downloading")*
 Default
 1575 Enter 4 Hexadecimal Digits
- [75] Answering Machine Double-call Timer *(Section 5.9 "Downloading")*
 Default
 060 (Valid entries are 001-255 seconds)
- [77] [Installer Code] [77] Initiate Local Downloading (PC-LINK) *(Section 5.9 "Downloading")*
- [79] LINKS 1000 Preamble (Downloading Telephone Number) *(Section 5.9 "Downloading")*
 Default
 FFFF (Program all unused digits with Hex F)

Module Programming

PROGRAMMING WORKSHEETS

[87] PC5400 Programming (Printer Module) *(Section 5.24 "On-Site Printer")*

[01] Printer Configuration

Default	Option	ON	OFF
OFF	<input type="checkbox"/> 1	Printer Enabled	Printer Disabled
ON	<input type="checkbox"/> 2	Handshake from Printer	No Handshake
OFF	<input type="checkbox"/> 3	80 Column Printer	40 Column Printer
OFF	<input type="checkbox"/> 4	300 Baud Enabled	Disabled
OFF	<input type="checkbox"/> 5	1200 Baud Enabled	Disabled
ON	<input type="checkbox"/> 6	2400 Baud Enabled	Disabled

[05] Printer Language Selection

Default
 01 (01=English 02=French 03=Spanish)

[88] DLM-1/DLM-4 Support Timers *(Section 5.25 "Downlook Video Transmission Module")*

Default
 01 Number of Pictures (Valid Entries are 01-08)
 00 Delay Before Capture at 100ms increments (Valid Entries are 00-99)

Special Installer Functions

PROGRAMMING WORKSHEETS

[90] [Installer's Code] [90] Installer Lockout Enable *(Section 5.27 "Installer's Lockout")*
 Enter [90] [Installer's Code] [90]

[91] [Installer's Code] [91] Installer Lockout Disable *(Section 5.27 "Installer's Lockout")*
 Enter [91] [Installer's Code] [91]

[92] [Installer's Code] [92] Module Supervision Reset *(Section 2.6 "Supervision")*
 Enter [91] [Installer's Code] [91]

[95] [Installer's Code] [95] Restore ESCORT to Factory Default Programming *(Section 5.26 "Resetting Factory Defaults")*
 Enter [95] [Installer's Code] [95]

[97] [Installer's Code] [97] Restore PC5400 to Factory Default Programming *(Section 5.26 "Resetting Factory Defaults")*
 Enter [96] [Installer's Code] [96]

[99] [Installer's Code] [99] Restore PC1575 to Factory Default Programming *(Section 5.26 "Resetting Factory Defaults")*
 Enter [99] [Installer's Code] [99]

Contact ID

A P P E N D I X A

The Partition ID Codes must be 4 digits. All reporting codes must be 2 digits.

The following is a list of Contact ID reporting codes. The first digit (in parentheses) will automatically be sent by the control. The last two digits are programmed to indicate specific information about the signal.

For example, if zone 1 is an entry/exit point, the alarm reporting code could be programmed as [34]. The central station would receive the following:

***BURG - ENTRY/EXIT - 1**

In the above example, the "1" indicates which zone went into alarm.



Do not program the following reporting codes: Opening After Alarm, Recent Closing and Event Buffer 75% Full.



When using a 2-wire smoke and Contact ID, the zone number will be identified as 99.

Event Codes (as per ADEMCO):

Medical Alarms

- (1)AA Medical
- (1)A1 Pendant Transmitter
- (1)A2 Fail to Report In

Fire Alarms

- (1)1A Fire Alarm
- (1)11 Smoke
- (1)12 Combustion
- (1)13 Water Flow
- (1)14 Heat
- (1)15 Pull Station
- (1)16 Duct
- (1)17 Flame
- (1)18 Near Alarm

Panic Alarms

- (1)2A Panic
- (1)21 Duress
- (1)22 Silent
- (1)23 Audible

Burglar Alarms

- (1)3A Burglary
- (1)31 Perimeter
- (1)32 Interior
- (1)33 24 Hour
- (1)34 Entry / Exit
- (1)35 Day / Night
- (1)36 Outdoor
- (1)37 Tamper
- (1)38 Near Alarm

General Alarms

- (1)4A General Alarm
- (1)43 Exp. module failure
- (1)44 Sensor tamper
- (1)45 Module Tamper

24 Hour Non-Burglary

- (1)5A 24 Hour non-Burg
- (1)52 Refrigeration
- (1)53 Loss of Heat
- (1)54 Water Leakage
- (1)55 Foil Break
- (1)56 Day Trouble
- (1)57 Low bottled Gas level
- (1)58 High Temp
- (1)59 Low Temp
- (1)61 Loss of Air Flow

Fire Supervisory

- (2)AA 24 Hour non-Burg
- (2)A1 Low Water Pressure
- (2)A2 Low CO2
- (2)A3 Gate Valve Sensor
- (2)A4 Low water level
- (2)A5 Pump activated
- (2)A6 Pump failure

System Troubles

- (3)AA System Trouble
- (3)A1 AC Loss
- (3)A2 Low System Battery
- (3)A3 RAM checksum bad*
- (3)A4 ROM checksum bad*
- (3)A5 System Reset*
- (3)A6 Panel prog. changed*
- (3)A7 Self-test failure
- (3)A8 System Shutdown
- (3)A9 Battery Test Failure
- (3)1A Ground Fault

Sounder / Relay Troubles

- (3)2A Sounder / Relay
- (3)21 Bell 1
- (3)22 Bell 2
- (3)23 Alarm Relay
- (3)24 Trouble Relay
- (3)25 Reversing

System Peripheral Troubles

- (3)3A System Peripheral
- (3)31 Polling Loop Open
- (3)32 Polling Loop Short
- (3)33 Exp. Module Failure
- (3)34 Repeater Failure
- (3)35 Local Printer Paper Out
- (3)36 Local Printer Failure

Communication Troubles

- (3)5A Communication
- (3)51 Telco 1 Fault
- (3)52 Telco 2 Fault
- (3)53 Lng-Rnge Rad. xmitr. fault
- (3)54 Fail to Communicate
- (3)55 Loss of radio super.
- (3)56 Loss of central polling

Protection Loop Troubles

- (3)7A Protection Loop
- (3)71 Protection Loop open
- (3)72 Protection Loop short
- (3)73 Fire Trouble

Sensor Troubles

- (3)8A Sensor Trouble
- (3)81 Loss of super. RF
- (3)82 Loss of super. RPM
- (3)83 Sensor Tamper
- (3)84 RF xmitter low batter

Open / Close

- (4)AA Open / Close
- (4)A1 O / C by User
- (4)A2 Group O / C
- (4)A3 Automatic O / C
- (4)A4 Late to O / C
- (4)A5 Deferred O / C
- (4)A6 Cancel
- (4)A7 Remote Arm / Disarm
- (4)A8 Quick Arm
- (4)A9 Keyswitch O / C

Remote Access

- (4)11 Callback request made*
- (4)12 Successful Download zaccess*
- (4)13 Unsuccessful access*
- (4)14 System Shutdown
- (4)15 Dialer Shutdown

Access Control

- (4)21 Access denied
- (4)22 Access report by user

System Disables

- (5)AA-(5)1A

Sounder / Relay Disables

- (5)2A Sounder / Relay disable
- (5)21 Bell 1 disable
- (5)22 Bell 2 disable
- (5)23 Alarm relay disable
- (5)24 Trouble relay disable
- (5)25 Reversing relay disable

System Peripheral Disables

- (5)3A-54A

Communication Disables

- (5)51 Dialer disabled
- (5)52 Radio xmitter disabled

Bypasses

- (5)7A Zone bypass
- (5)71 Fire bypass
- (5)72 24 Hour zone bypass
- (5)73 Burg bypass
- (5)74 Group bypass

Test / Misc.

- (6)A1 Manual Trigger Test*
- (6)A2 Periodic Test report*
- (6)A3 Periodic RF xmission*
- (6)A4 Fire test*
- (6)A5 Status report to follow*
- (6)A6 Listen-in to follow
- (6)A7 Walk test mode

* Restore not applicable

SIA Format

SIA Format

Level 2 (Hardcoded)

The SIA communication format used in this product follows the level 2 specifications of the SIA Digital Communication Standard - February 1993. This format will send the Account Code along with its data transmission. At the receiver, the transmission would look similar to this example:

N Ri01 BA 01

N = New Event

Ri01 = Partition / Area Identifier

BA = Burglary Alarm

01 = Zone 1

PC1575 Reporting Codes

SIA Identifiers & Auto-Reporting Code

Delay Zone Alarm / Restore	BA-XX / BH-XX*
Instant Zone Alarm / Restore	BA-XX / BH-XX*
Interior Zone Alarm / Restore	BA-XX / BH-XX*
Delay H.A. Zone Alarm / Restore	BA-XX / BH-XX*
Interior H.A. Zone Alarm / Restore	BA-XX / BH-XX*
24 Hr Burg Zone Alarm / Restore	BA-XX / BH-XX*
Standard Fire Zone Alarm / Restore	FA-XX / FH-XX*
Delayed Fire Zone Alarm / Restore	FA-XX / FH-XX*
24 Hr Supervisory Buzzer Zone Alarm / Restore ..	UA-XX / UH-XX*
24 Hr Supervisory Zone Alarm / Restore	UA-XX / UH-XX*
24 Hr Medical Zone Alarm / Restore	MA-XX / MH-XX*
24 Hr Panic Zone Alarm / Restore	PA-XX / PH-XX*
24 Hr Holdup Zone Alarm / Restore	HA-XX / HH-XX*
24 Hr Heat Zone Alarm / Restore	KA-XX / KH-XX*
24 Hr Emergency Zone Alarm / Restore	QA-XX / QH-XX*
24 Hr Sprinkler Zone Alarm / Restore	SA-XX / SH-XX*
24 Hr Water Zone Alarm / Restore	WA-XX / WH-XX*
24 Hr Freeze Zone Alarm / Restore	ZA-XX / ZH-XX*
24 Hr Latching Tamper Alarm / Restore	BA-XX / BH-XX*
Duress Alarm	HA-00
Opening After Alarm	OR-00
Keypad Fire Alarm / Restore	FA-00 / FH-00
Keypad Auxiliary Alarm / Restore	MA-00 / MH-00

PC1575 Reporting Codes

SIA Identifiers & Auto-Reporting Code

Keypad Panic Alarm / Restore	PA-00 / PH-00
2-Wire Smoke Alarm / Restore	FA-00 / FH-00
Zone Tamper (1-6)	TA-XX*
Zone Tamper Restorals (1-6)	TR-XX*
General System Tamper / Restore	TA-00 / TR-00
Closing By Access Codes 1-6	CL-XX
Partial Closing	CG-XX ▼
Opening By Access Codes 1-6	OP-XX ◆
Battery Trouble Alarm / Restore	YT-00 / YR-00
AC Failure Trouble Alarm / Restore	AT-00 / AR-00
Bell Circuit Trouble Alarm / Restore	UT-99 / UJ-99
Fire Trouble Alarm / Restore	FT-00 / FJ-00
Auxiliary Power Supply Trouble Alarm / Restore ..	YP-00 / YQ-00
TLM Trouble Code (via LINKS)	LT-00
General System Supervisory / Restore	ET-00 / ER-00
TLM Restoral	LR-00
FTC Restoral	YK-00
Event Buffer 75% Full Since Last Upload	JL-00
Periodic Test Transmission	RP-00
System Test	RX-00
LINKS1000 Test Transmission Code	TX-00
General Zone Fault Alarm/ Restore	UT-00 / UJ-00*
Burglary Verified	BV-00
Closing Delinquent	CD-00

* Zone Number is Identified

◆ User Number is Identified

▼ Each Zone Number is Identified (using UB-XX)

Programming LCD Keypads

A P P E N D I X C

If you have an LCD5500 Keypad, additional programming is required for proper operation. The following is a description of the available programming options and their accompanying programming sections:

How to Enter LCD Programming

Follow the programming procedure as outlined in Section 4 by pressing [★] [8] [Installer's Code]. Press the [★] key. Enter the two digit Section number to be programmed.

Programmable Labels – Sections [01] - [06], [40], [44], [51], [52], [60] - [64], [66]

Zone labels and other LCD display identifiers can be customized to make operation of the system easier for the end user. The following procedure should be used for creating all LCD labels:

- Enter Installer's Programming. Enter the Number corresponding to the label to be programmed.
- Use the arrow keys (<>) to move the underline bar underneath the letter to be changed.
- Press the number key [1] to [9] corresponding to the letter you require. The first time you press the number the first letter will appear. Pressing the number key again will display the next letter. Refer to the following chart:
 [1] - A, B, C, 1 [2] - D, E, F, 2 [3] - G, H, I, 3 [4] - J, K, L, 4 [5] - M, N, O, 5
 [6] - P, Q, R, 6 [7] - S, T, U, 7 [8] - V, W, X, 8 [9] - Y, Z, 9,0 [0] - Space
- When the required letter or number is displayed use the arrow keys (<>) to scroll to the next letter.
- When you are finished programming the Zone Label, press the [★] key, scroll to "Save," then press [★].
- Continue from Step 2 until all Labels are programmed.

[01] to [06] Zone Labels (14 Characters)

Default to

[33] Fire Alarm Label (14 Characters)

Default

[34] System Label (14 Characters)

Default

[40] "Utility Output" Label (14 Characters)

Default

[44] "Sensor Reset" Label (14 Characters)

Default

[51] Fail to Arm Event Message

Default

[52] Alarm When Armed Event Message

Default

[60] First User Display Mask

Default	Option	ON	OFF
ON	<input type="checkbox"/>	1 Hold [P]anic Keys prompt ON	Hold [P]anic Keys prompt OFF
ON	<input type="checkbox"/>	2 Zone Bypassing prompt ON	Zone Bypass prompt OFF
ON	<input type="checkbox"/>	3 Troubles prompt ON	Troubles prompt OFF
ON	<input type="checkbox"/>	4 Alarm Memory prompt ON	Alarm Memory prompt OFF
ON	<input type="checkbox"/>	5 Door Chime Control prompt ON	Door Chime Control prompt OFF
ON	<input type="checkbox"/>	6 Access Codes prompt ON	Access Codes prompt OFF
ON	<input type="checkbox"/>	7 User Functions prompt ON	User Functions prompt OFF
ON	<input type="checkbox"/>	8 Output Control prompt ON	Output Control prompt OFF

[61] Second User Display Mask

Default	Option	ON	OFF
OFF	<input type="checkbox"/>	1 Installer Programming prompt ON	Installer Programming prompt OFF
ON	<input type="checkbox"/>	2 Stay Arm prompt ON	Stay Arm prompt OFF
ON	<input type="checkbox"/>	3 Quick Arm prompt ON	Quick Arm prompt OFF
ON	<input type="checkbox"/>	4 Interior Arm prompt ON	Interior Arm prompt OFF
OFF	<input type="checkbox"/>	5 Quick Exit prompt ON	Quick Exit prompt OFF
ON	<input type="checkbox"/>	6 View Event Buffer prompt ON	View Event Buffer prompt OFF
OFF	<input type="checkbox"/>	7 Baby Input prompt ON	Baby Input prompt OFF
OFF	<input type="checkbox"/>	8 Music Input ON	Music Input OFF

[62] Third User Display Mask

Default	Option	ON	OFF
ON <input type="checkbox"/>	1	System Test prompt ON	System Test prompt OFF
ON <input type="checkbox"/>	2	Time and Date prompt ON	Time and Date prompt OFF
ON <input type="checkbox"/>	3	Auto-Arm Control prompt ON	Auto-Arm Days prompt OFF
ON <input type="checkbox"/>	4	Auto-Arm Time prompt ON	Auto-Arm Time prompt OFF
ON <input type="checkbox"/>	5	Download Enable prompt ON	Download Enable prompt OFF
ON <input type="checkbox"/>	6	Bright Control prompt ON	Bright Control prompt OFF
ON <input type="checkbox"/>	7	Contrast Control prompt ON	Contrast Control prompt OFF
ON <input type="checkbox"/>	8	Buzzer Control prompt ON	Buzzer Control prompt OFF

[63] Downloaded LCD Message Duration

Default
 003 (Valid entries are 000-255, 000=Unlimited Message Display. This number represents the number of times the Downloaded message is cleared by pressing any key while the message is up after timeout)

[64] Key Options

Default	Option	ON	OFF
ON <input type="checkbox"/>	1	[F]ire Keys enabled	[F]ire Keys disabled
ON <input type="checkbox"/>	2	[A]uxiliary Keys enabled	[A]uxiliary Keys disabled
ON <input type="checkbox"/>	3	[P]anic Keys enabled	[P]anic Keys disabled
OFF <input type="checkbox"/>	4-8	For Future Use	

[65] Fourth User Display Mask

Default	Option	ON	OFF
ON <input type="checkbox"/>	1	User Initiated Call-up Prompt ON	User Initiated Call-up Prompt OFF
ON <input type="checkbox"/>	2	Last Code to Disarm/Arm Prompt ON	Last Code to Disarm/Arm Prompt OFF
ON <input type="checkbox"/>	3	Walk Test Prompt ON	Walk Test prompt OFF

[66] Keypad Options

Default	Option	ON	OFF
ON <input type="checkbox"/>	1	Display Access Code when Programming	Display 'X' when Programming
ON <input type="checkbox"/>	2	Local Clock Display Enabled	Local Clock Display Disabled
OFF <input type="checkbox"/>	3-8	For Future Use	

[97] View Software Version

[98] Initiate Global Label Broadcast

All LCD programming is done per keypad. If more than one LCD keypad are present on the system, labels programmed at one keypad can be broadcast to all other LCD keypads. Perform the following procedure in order to broadcast labels:

Step 1 - Program one LCD keypad completely.

Step 2 - Make sure all LCD keypads are connected to the KEYBUS.

Step 3 - Enter Installer's Programming, then enter Section [98] at the keypad that was programmed. The keypad will now broadcast all the information programmed to all the other LCD keypads on the system.

Step 4 - When the keypad is finished press the [#] key to exit.

[99] Reset LCD EEPROM to Factory Defaults

ASCII Characters

	#	&)	,	/	<	?	^		←	W	g	ñ	q	Σ	÷
032	035	038	041	044	047	060	063	094	124	127	228	231	238	241	246	253
	!	\$	'	*	—	#	=	@	_	}	.	ç	j	ö	ø	×
033	036	039	042	045	058	061	064	095	125	176	229	234	239	244	248	254
	"	%	(+	.	;	>]	(→	ä	ø	ø	ü	Y	■
034	037	040	043	046	059	062	093	123	126	225	230	236	240	245	249	255

PGM Output Options

Establishing PGM Output Types

Each PGM output is designed so that when activated by the panel, the terminal will switch to ground.

PGM 1 – 50mA Current

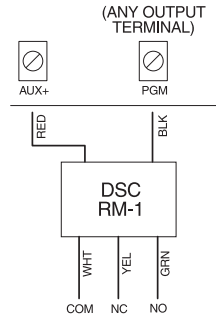

PGM1 can sink up to 50 mA of current to activate LEDs or a small buzzer. Connect the positive side of the LED or buzzer to AUX+, the negative side to PGM1. If more than 50 mA of current are required, a relay must be used. Please study PGM wiring in the accompanying diagram.

PGM 2 – 50mA Current (Standard Option)

Because jumper CON1 is not present on the circuit board diagram below, the panel is a PC1575 (standard option). This means that PGM2 is rated at 50mA and does not support 2-wire smoke detectors.

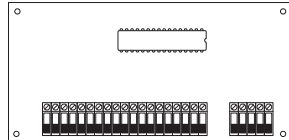

PGM2 outputs are connected the same way as PGM1 outputs.

PGM2 – 300mA Current (2-wire Smoke Option)

Because jumper CON1 is present on the circuit board diagram below, the panel is a PC1575 (2-wire smoke option). This means that PGM2 is rated at 300mA and will support 2-wire smoke detectors. (See Section 2.8 "Zone Wiring – Fire Zone Wiring"). Note that the jumper CON1 must be removed when PGM2 is programmed for Downlook, 2-wire smoke support, keyswitch arming, 24 hour operation or forced answer.

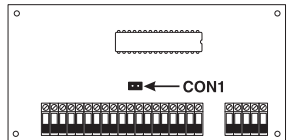

PGM2 outputs are connected the same way as PGM1 outputs.

PGM Output Options [01] - [15]

Both programmable outputs – PGM1 and PGM2 – on the main board can be programmed by selecting one of the output options listed below.

PGM output options [01] to [15] can be programmed for both PGM1 and PGM2.

..... **Main Board PGM Outputs** **Section [06]**

[01] Ground Start Pulse

The PGM Output will activate for two seconds to obtain a dial tone on Ground Start telephone equipment before the panel attempts to dial. Two 2-second pauses should be inserted at the beginning of the phone number when using this option.

[02] Utility Output with any Access Code

The PGM output will activate for 5 seconds when the [*] [7] [1] [Access Code] command is entered (see Section 3.0 – "Keypad Commands").

[03] Sensor Reset



This output will normally be active and switched to ground.

This option is used to reset power for latching smoke detectors. The output will deactivate for five seconds when the [*] [7] [2] command is entered (see Section 3.4 "[*] [7] Output Functions"). The keypad buzzer will not sound for the five second period.

Please refer to the Hook-Up diagram in this manual for wiring instructions.

[04] Courtesy Pulse

Upon arming, the PGM output will activate for the duration of the exit delay plus an additional two minutes. Upon entry, the PGM output will activate for the duration of the entry delay plus an additional two minutes.

[05] Keypad Buzzer Follower Mode

The PGM will activate when any of the following events occur and will remain active for as long as the keypad buzzer is active:

- Door Chime
- Auto-Arm Prealert
- 24 Hour Supervisory Buzzer Zone
- Entry Delay
- Audible Exit Delay

[06] System Armed Status

When the system is armed, the PGM output will switch to ground at the beginning of the exit delay. The output goes high (open) when the panel is disarmed.

[07] Latched System Event (Strobe Output)

The PGM output will switch to ground when any of the system events (alarms) occur on the system. In the armed state, the output will deactivate only when the system is disarmed. If an alarm activates this output in the disarmed state, the output will deactivate if the bell is silenced during a bell time-out, or if the system is armed after the bell time-out. This PGM output can be used to indicate that an alarm has occurred before entering the premises.

This output will activate for all silent and audible alarms of the following types:

- Burglary Delay, Instant, Interior, Stay/Away and 24 Hour Burglary Zones
- Fire Fire Keys, Fire Zone and 2-wire Smoke Zone (PGM Output)
- Panic Panic Keys and Panic
- Auxiliary Auxiliary Keys, Auxiliary and Emergency Zones
- Supervisory.. Supervisory, Freezer and Water Zones
- Priority Heat, Sprinkler and 24 Hour Latching Zones



This output will activate for alarm conditions only. Pre-alerts or delays will not activate the output. This output should only be activated for all audible alarms or medical conditions

[08] Failure to Communicate or Telephone Line Monitoring Trouble

The PGM output switches to ground when either of the two telephone line troubles are detected on the system (see Section 3.4 – "[*] Commands: [*] [2] Trouble Conditions"). The output will deactivate when neither trouble is present.

[09] Entry Delay Follower

The PGM output switches to ground for the duration of the Entry Delay.

[10] Exit Delay Follower

The PGM output switches to ground for the duration of the Exit Delay.



If this feature is used in conjunction with courtesy pulse, it will terminate at the end of the courtesy pulse time, not at the end of the exit delay.

[11] TLM and Alarm

The PGM output switches to ground when the system experiences both a telephone line trouble and an alarm. When the system is armed, the output will deactivate only if an access code is entered. If the output is activated by an alarm in the disarmed state, it will only deactivate if the bell is silenced during bell time-out or if the system is armed after the bell time-out.

! *This output will activate for all silent and audible alarms except the Duress alarm.*

[12] Police Code Follower

The PGM output switches to ground if two different zones go into alarm during the same armed period. The Police Code will be sent to the central station and this output will activate. This output is latched.

[13] 20 Minute Latched Alarm

The PGM output will switch to ground upon an alarm and will latch for 20 minutes or until disarmed. If activated while disarmed, this output will be deactivated after 20 minutes or if a code is entered during bell time out or if the panel is armed.

[14] Line Seizure





The output will switch to ground while the panel has seized the telephone line for downloading purposes or to communicate to the central station.

[15] Ready To Arm

The PGM switches to ground as long as the system is ready to arm and all non-force armable zones on the system are restored. Once an access code is entered to arm the system and the exit delay begins, the PGM output is deactivated.

PGM Output Options [16] - [30]

PGM output options [16] to [30] have specific PGM output requirements and are represented by the following icons:

-  Option [16] is for PGM1 ONLY.
-  Options [25] - [30] is for PGM2 ONLY
-  Options [17] - [30] require that the connector CON1 be removed from the PC1575 (2-wire smoke option) control board. If you have a PC1575 (standard option), CON1 is already removed.
-  Option [25] "2-wire Smoke Support" requires a PC1575 (2-wire smoke option). This option cannot be programmed on a PC1575 (standard option).

Main Board PGM Outputs Section [06]



[16] LINKS 1000 Support 

The PGM output will be used as a data wire to communicate phone number information for the LINKS 1000 cellular unit.

[17] Downlook Support 

This option configures the PGM terminals for operation with the DLM-1 or DLM-4 Video Capture module.

! *Option 17 must be used on both PGM1 and PGM2 for Downlook Support. PGM1 connects to the DLM DTA and the PGM2 connects to the DLM CLK.*

[25] 2-Wire Smoke Support   

When this option is selected, the PGM functions much like option [03] in that it is a normally low output supplying the negative return. However, 2-wire smoke detectors can be supported, meaning that a zone input need not be used. The 2-wire smoke detector input is an instant and latching alarm requiring manual resetting. This input does not follow Swinger Shutdown.

! *2-Wire smoke detectors use PGM2 as a supervised input. A trouble condition will be generated with the absence of a 2200Ω resistor between PGM2 and Aux+ .*

[26] Momentary Key Switch Arm  

A key switch module may be connected to the zone programmed as Momentary Key Switch Arm. Momentary activation of this zone will alternately arm and disarm the system and silence alarms. Note that the keypad will not display an indication when this type of zone is activated. This input does not follow Swinger Shutdown.

[27] Maintained Key Switch Arm  

A Normally Open Key Switch module may be connected to the zone programmed as Maintained Key Switch Arm. In the restored state, the panel is disarmed. Any violation of the zone will cause the system to arm (alarm, tamper or fault). To be used with the Block Schloss module. This input does not follow Swinger Shutdown.

! *Both types of Key Switch zones will sound a keypad error tone if zones are open and if the user attempts to arm the system. The Maintained Key Switch will provide an error tone if an attempt is made to arm an already armed system, or to disarm an already disarmed system.*

[28] Silent 24 Hour  

A Panic button may be placed on the PGM2 terminal for use as a silent 24 hour Panic. The keypad will not indicate the alarm in any way and the Bell will remain silent but the PGM2 Alarm reporting code will be sent to the central station. This input does not follow Swinger Shutdown.

[29] Audible 24 Hour  

A Panic button may be placed on the PGM2 Terminal for use as an Audible 24 Hour Panic. The keypad will not indicate the alarm in any way but the bell will sound for the duration of the bell time out and the PGM2 Alarm reporting code will be sent to the central station. This input does not follow Swinger Shutdown.

[30] Forced (LINKS) Answer  

This output provides the ability to have the panel answer the phone line and look for a downloading computer without having to see the programmed number of rings or a valid double call. This output is also for use with a LINKS 1000 for downloading purposes. This zone is similar to a fire zone in that the supervision options (NC,EOL,DEOL) do not affect zone functioning.

The restored state of this zone type is 2200Ω; the open state causes the panel to answer. A 2200 ohm resistor must be placed across the LINKS RING and zone terminals. Normally, the RING terminal would be ground, therefore presenting the 2200 ohms to the zone input. If the RING terminal opens, the panel will seize the telephone line. This input does not follow Swinger Shutdown.

Appendix E

UL REQUIREMENTS

The following requirements apply to UL Listed systems:

1. All components of the system should be UL listed for the intended application.
2. If this system is configured for "fire", the installer should refer to chapter 2 of NFPA 72 for details in locating smoke detectors and the typical installation layout shown below.
3. Note that at least one UL listed compatible audible signal appliance shall be installed indoors.
4. The maximum entry delay times are as follows: Residential - 45s; Commercial - 60s.
5. The maximum exit delay times are as follows: Residential and Commercial: 60s.
6. The minimum bell cutoff times are: Residential - 4 min; Commercial - 15 min.
The installer should advise the user on system operation and record the source organization name, telephone number, entry and exit times.
7. Remote programming shall be disabled.
8. The following accessories/modules are not UL listed and shall not be used with the control unit: PC5400, RS232 serial interface module, ESCORT5580 voice prompt modules, PC-Link adaptor, LINKS1000, DLM-1/DLM-4 Downlook modules, PC5004C cabinet.
9. Obvious or common user codes such as 1111 or 1234 should be avoided.
10. The following programming shall be performed:
 - A. The delayed 24hr Fire Zone shall not be used.
 - B. If used, the 24hr heat, 24hr auxiliary, 24hr intrusion emergency, 24hr sprinkler, 24hr waterflow and 24hr freezer zones shall be programmed as silent.
 - C. The Force Arm enable attribute shall be disabled for all zones.
 - D. The Downlook Activation option shall be disabled for all zones.

- E. In commercial burglary applications, the Communications Enable option shall be selected.
- F. In commercial burglary applications, the Closing Confirmation option shall be enabled.
- G. The test transmission cycle shall be 1 day.
- H. The Quick Exit feature shall be disabled.
- I. The Bypass Status Displayed While Armed feature shall be disabled.
- J. The Swinger Shutdown feature shall be disabled.
- K. The Call LINKS as well as Land Line option shall be disabled.
- L. The Code Required for Bypassing option shall be enabled.
- M. The AC Trouble Displayed feature shall be enabled.
- N. The Trouble Light Flashes if AC Fails location shall be enabled.
- O. The Transmission Delay shall not exceed 15s.
- P. The Downloading Answer, Call-back and User Initiated Call-up and Periodic Download features shall be disabled.
- Q. For a fire type zone, the bell output shall be passing.
- R. For burglary type zones, the bell output shall be steady.

11. The PC1575 shall be used with the following listed receivers and formats:

Silent Knight Model 9000 - 3/1, 4/1, 4/2 non-extended; 3/1 extended, 10md 20 bps, 1400Hz handshake

Ademco 685 - 3/1, 4/1 and 4/2 non-extended; 3/1 extended, 20bps, 1400Hz handshake. SESCO super speed and SESCO super speed with identified openings/closings.

Lincar Model 3000 - 3/1, 4/1 and 4/2 non-extended; 3/1 extended, 20bps, 1400Hz handshake. SESCO super speed and SESCO super speed with identified openings/closings.

Radionics Model D6500 - 3/1, 4/2 non-extended; 3/1 extended with and without parity, 1400 and 2300Hz handshake.

Guidelines for Locating Smoke Detectors

Experience has shown that all hostile fires in family living units generate smoke to a greater or lesser extent. Experiments using typical fires in family living units indicate that detectable quantities of smoke precede detectable levels of heat in most cases. For these reasons, NFPA standard 72 requires smoke detectors to be installed outside of each sleeping area and on each additional story of the family unit.

The following information is for general guidance only and it is recommended that NFPA standard 72 be consulted and that the smoke detector manufacturer's literature be used for detailed installation instructions.

It is recommended that additional smoke detectors beyond those required be installed for increased protection. The added areas include: basement, bedrooms, dining rooms, furnace room, utility room and hallways not protected by the required detectors.

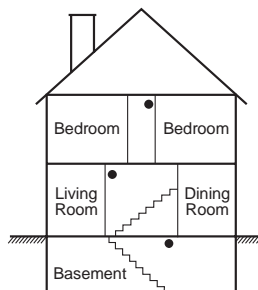

FIG. 3: A smoke detector should be located on each story of the living unit.

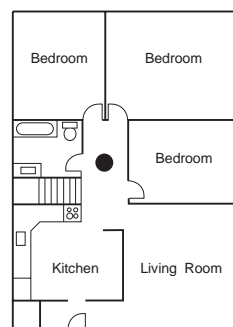

FIG. 1: A smoke detector should be located between the sleeping area and the rest of the family unit.

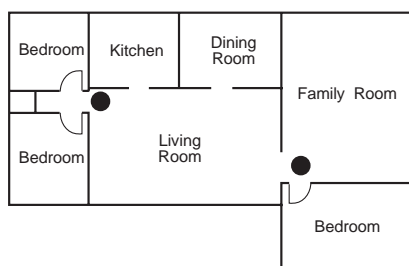
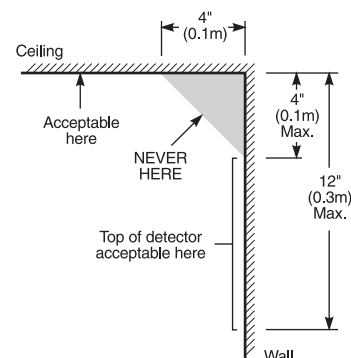

FIG. 2: In the family living units with more than one sleeping area, a smoke detector should be located to protect each sleeping area.

FIG. 4: Smoke Detector mounting - "Dead" Air Space. The smoke from a fire generally rises to the ceiling, spreads out across the ceiling surface and begins to bank down from the ceiling. The corner where the ceiling and wall meet is an air space into which the smoke may have difficulty penetrating. In most fires, this "dead" air space measures about 4 in. (0.1m) along the ceiling from the corner and about 4 in. (0.1m) down the wall as shown in Figure 4. Detectors should not be placed in the "dead" air space.



NOTE: Measurements shown are to the closest edge of the detector.

Control Panel Wiring Diagram

PC1575 CONTROL PANEL WIRING DIAGRAM

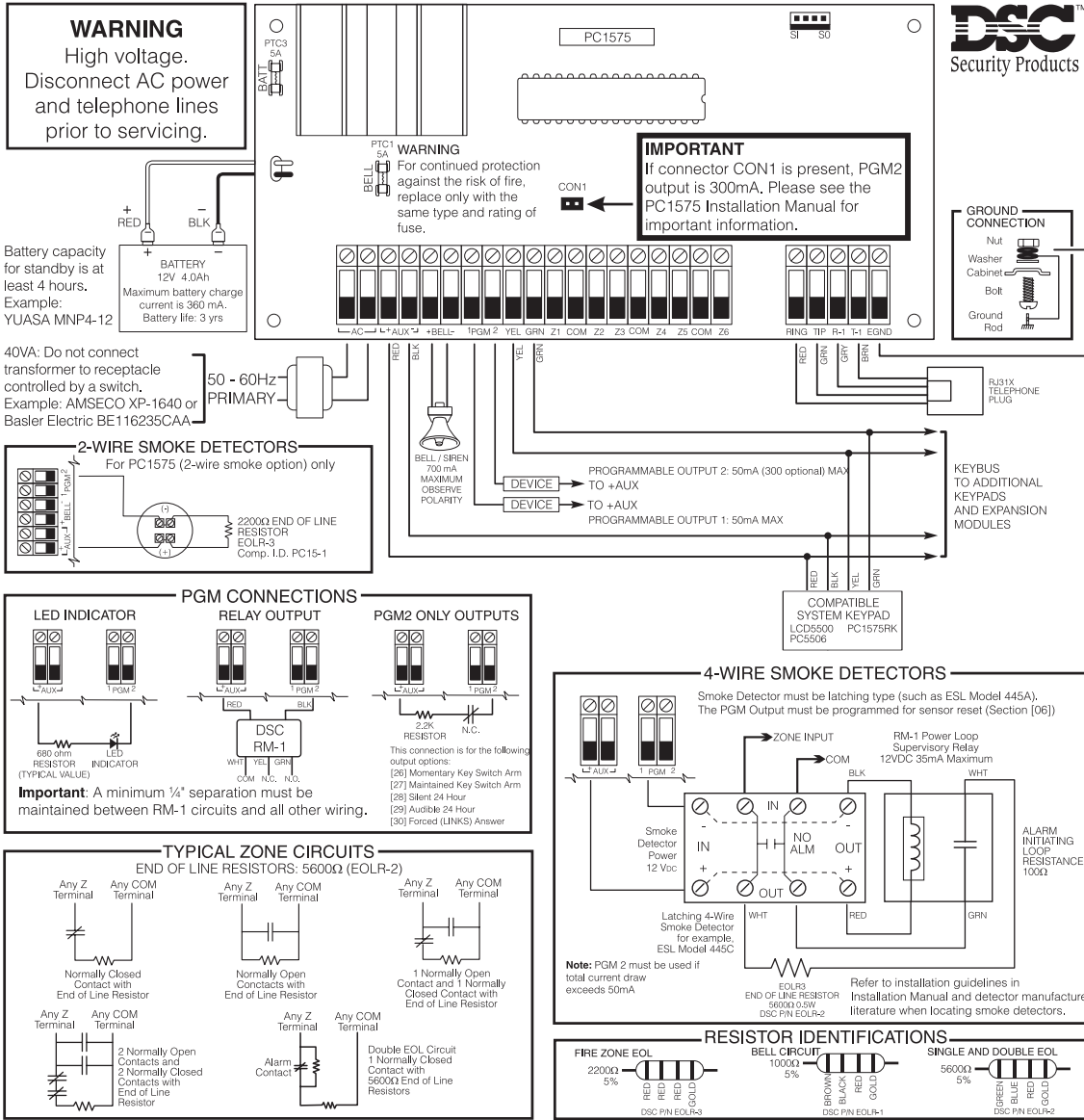

Temperature Range: 0°C-49°C (32°F-120°F); Maximum Humidity: 85% R.H.
Refer to the Installation and Instruction Manuals for complete operating instructions.

The PC1575 is UL-listed for limited energy installations per NEC Article 760. Recognized limited energy cable should be used. Observe NEC wiring requirements and local codes defined by the authority having jurisdiction.

This equipment should be installed in accordance with ANSI/NFPA 72-1993 (National Fire Protection Association, Batterymarch Park, Quincy MA, 02269). Printed information describing proper installation, operation, testing, maintenance, evacuation planning, and repair service is to be provided with this equipment.

Security detection devices that require power from the control panel must be UL-listed for the intended application and operate over the range of 11.6 - 12.6 VDC (residential), 12.0 VDC (commercial). The DSC Bravo Series is a recommended UL-listed motion detector.

Compatible System Keypads: PC1575RK, PC5506, LCD5500

APPLICABLE UL STANDARDS: UL FILE NO. S4019

UL1610 Central-Station Burglar-Alarm Units
UL609 Local Burglar Alarm Units and Systems
UL365 Police Station Connected Burglar Alarm Units and Systems
UL985 Household Fire Warning System Units

UL1023 Household Burglar-Alarm System Units
UL1635 Digital Alarm Communicator System Units
Control Panel is suitable for the following UL installations:
- Household Fire and Grade A Household Burglary
- Grade A Local I Grade B Central Station and Police Connect with basic line security
- Grade C Central Station
Refer to Installation manual; p/n 29002069 r0.

This device complies with Parts 15 and 68 of the FCC rules. Operation is subject to the following two conditions: (1) this device may not cause harmful interference, and (2) this device must accept any interference received, including interference that may cause undesired operation.

FCC Reg. No.: F53CAN-30220-AL-E REN = 0.1B Plug Type: RJ31X
INDUSTRY CANADA: LOAD NUMBER / INDICE DE CHARGE 0,1B
MADE IN CANADA
Digital Security Controls, Ltd. 1645 Flint Road, Downsview, Ontario, Canada M3J 2J6

WARNING: Not to be removed by anyone except occupant.

NOTICE!

You must read this entire manual, including all notices and warnings, in order to install this system so that it is fully functional.

WARNING!

This entire system must be completely tested on a regular basis to verify the operation of all system functions, in accordance with the recommendations of the security systems industry. However, despite frequent testing, and due to, but not limited to, criminal tampering or electrical disruption, it is possible that this product could fail to perform as expected.

Table of Contents

Section 1 - PC1575 System Introduction	1	Section 3 - Keypad Commands	7
1.1 Specifications	1	3.1 Arming and Disarming	7
1.2 Additional Devices	2	3.2 Auto Bypass – Stay Arming	7
1.2.1 Keypads	2	3.3 Automatic Arming	7
1.2.2 ESCORT5580 Module	2	3.4 [Q] Commands	7
1.2.3 PC5400 Printer Module	2	3.5 Function Keys	11
1.2.4 Downlook Video Transmission Module	2	3.5.1 Function Key Options	11
1.2.5 LINKS 1000 Cellular Communicator	2	Section 4 - How to Program	12
1.2.6 Cabinets	2	4.1 Installer's Programming	12
1.3 Out of the Box	2	4.2 Programming Decimal Data	12
Section 2 - Getting Started	3	4.3 Programming HEX Data	12
2.1 Installation Steps	3	4.4 Programming Toggle Option Sections	12
2.2 Terminal Descriptions	3	4.5 Viewing Programming	13
2.3 KEYBUS Operation and Wiring	4	Section 5 - Program Descriptions	14
2.4 Current Ratings – Modules and Accessories	4	5.1 Programming Security Codes	14
2.5 Keypad Assignment	4	5.2 Zone Definitions	14
2.6 Supervision	5	5.3 Zone Attributes	15
2.7 Removing Modules	5	5.4 Communicator – Dialing	15
2.8 Zone Wiring	5	5.5 Communicator – Account Numbers	15
2.8.1 Normally Closed (NC) Loops	5	5.6 Communicator – Phone Numbers	15
2.8.2 Single End Of Line (EOL) Resistors (5600W)	5	5.7 Communicator – Reporting Codes	16
2.8.3 Double End of Line (DEOL) Resistors	5	5.7.1 Zone Alarm	16
2.8.4 Fire Zone Wiring — 4-Wire Smoke Detectors	5	5.7.2 Zone Restoral	16
2.8.5 Fire Zone Wiring – 2-Wire Smoke Detectors	6	5.7.3 Closings (Arming Codes)	16
2.8.6 Keyswitch Zone Wiring (PGM2)	6	5.7.4 Openings (Disarming Codes)	16
2.8.7 LINKS Support	6	5.7.5 Tamperers	16
2.8.8 LINKS Supervisory	6	5.7.6 Priority/Emergency	16
2.8.9 LINKS Answer	6	5.7.7 Maintenance	17
		5.7.8 Test Transmissions	17
		5.7.9 Miscellaneous	17

<p>5.8 Communicator – Reporting Formats 17</p> <p style="padding-left: 20px;">5.8.1 Pulse Formats 17</p> <p style="padding-left: 20px;">5.8.2 Contact ID 18</p> <p style="padding-left: 20px;">5.8.3 SIA 18</p> <p style="padding-left: 20px;">5.8.4 Pager Format 18</p> <p>5.9 Downloading 18</p> <p>5.10 Telephone Line Monitor (TLM) 19</p> <p>5.11 Siren Supervision 19</p> <p>5.12 Test Transmission 19</p> <p>5.13 Fire, Auxiliary and Panic Keys – [F], [A], [P] 20</p> <p>5.14 Arming/Disarming Options 20</p> <p>5.15 Entry/Exit Delay Options 20</p> <p>5.16 Swinger Shutdown 20</p> <p>5.17 Transmission Delay 21</p> <p>5.18 Event Buffer 21</p> <p>5.19 Keypad Lockout 21</p> <p>5.20 Keypad Blanking 21</p> <p>5.21 Loop Response 21</p> <p>5.22 Keypad Tamper 21</p> <p>5.23 LINKS 1000 Cellular Communicator 21</p> <p style="padding-left: 20px;">5.23.1 Using LINKS 1000 as the Sole Communicator .. 21</p> <p style="padding-left: 20px;">5.23.2 Using the LINKS 1000 as a Backup Communicator 21</p> <p style="padding-left: 20px;">5.23.3 Using the LINKS as a Redundant Communicator . 22</p> <p>5.24 On-Site Printer 22</p>	<p>5.25 Downlook Video Transmission Module 22</p> <p>5.26 Resetting Factory Defaults 22</p> <p>5.27 Installer's Lockout 22</p> <p>Programming Worksheets 23</p> <p>Appendix A - Contact ID 32</p> <p>Appendix B - SIA Format 33</p> <p>Appendix C - Programming LCD Keypads 34</p> <p>ASCII Characters 35</p> <p>Appendix D - PGM Output Options 36</p> <p>Appendix E - UL Requirements 38</p> <p>Control Panel Wiring Diagram 39</p> <p>Table of Contents 40</p> <p>Limited Warranty 41</p> <p>Industry Canada Notice 42</p> <p>FCC COMPLIANCE STATEMENT 42</p>
--	---

Limited Warranty

Digital Security Controls Ltd. warrants that for a period of twelve months from the date of purchase, the product shall be free of defect in materials and workmanship under normal use and that in fulfillment of any breach of such warranty, Digital Security Controls Ltd. shall, at its option, repair or replace the defective equipment upon return of the equipment to its repair depot. This warranty applies only to defects in parts and workmanship and not to damage incurred in shipping or handling, or damage due to causes beyond the control of Digital Security Controls Ltd. such as lightning, excessive voltage, mechanical shock, water damage, or damage arising out of abuse, alteration or improper application of the equipment.

The foregoing warranty shall apply only to the original buyer, and is and shall be in lieu of any and all other warranties, whether expressed or implied and of all other obligations or liabilities on the part of Digital Security Controls Ltd. This warranty contains the entire warranty. Digital Security Controls Ltd. neither assumes, nor authorizes any other person purporting to act on its behalf to modify or to change this warranty, nor to assume for it any other warranty or liability concerning this product.

In no event shall Digital Security Controls Ltd. be liable for any direct, indirect or consequential damages, loss of anticipated profits, loss of time or any other losses incurred by the buyer in connection with the purchase, installation or operation or failure of this product.

WARNING: This entire system must be completely tested on a regular basis to verify the operation of all system functions, in accordance with the recommendations of the security systems industry. However, despite frequent testing, and due to, but not limited to, criminal tampering or electrical disruption, it is possible for this product to fail to perform as expected.

Industry Canada Notice

AVIS: L'étiquette de l'Industrie Canada identifie le matériel homologué. Cette étiquette certifie que le matériel est conforme à certaines normes de protection, d'exploitation et de sécurité des réseaux de télécommunications. Industrie Canada n'assure toutefois pas que le matériel fonctionnera à la satisfaction de l'utilisateur.

Avant d'installer ce matériel, l'utilisateur doit s'assurer qu'il est permis de le raccorder aux installations de l'entreprise locale de télécommunication. Le matériel doit également être installé en suivant une méthode acceptée de raccordement. L'abonné ne doit pas oublier qu'il est possible que la conformité aux conditions énoncées ci-dessus n'empêchent pas la dégradation du service dans certaines situations.

Les réparations de matériel homologué doivent être effectuées par un centre d'entretien canadien autorisé désigné par le fournisseur. La compagnie de télécommunications peut demander à l'utilisateur de débrancher un appareil à la suite de réparations ou de modifications effectuées par l'utilisateur ou à cause de mauvais fonctionnement.

Pour sa propre protection, l'utilisateur doit s'assurer que tous les fils de mise à la terre de la source d'énergie électrique, les lignes téléphoniques et les canalisations d'eau métalliques, s'il y en a, sont raccordés ensemble. Cette précaution est particulièrement importante dans les régions rurales.

AVERTISSEMENT: L'utilisateur ne doit pas tenter de faire ces raccordements lui-même; il doit avoir recours à un service d'inspection des installations électriques, ou à un électricien, selon le cas.

L'indice de charge (IC) assigné à chaque dispositif terminal indique, pour éviter toute surcharge, le pourcentage de la charge totale qui peut être raccordée à un circuit téléphonique bouclé utilisé par ce dispositif. La terminaison du circuit bouclé peut être constituée de n'importe quelle combinaison de dispositifs, pourvu que la somme des indices de charge de l'ensemble des dispositifs ne dépasse pas 100.

L'Indice de charge de ce produit est 2.

NOTICE: The Industry Canada label identifies certified equipment. This certification means that the equipment meets certain telecommunications network protective, operational and safety requirements. Industry Canada does not guarantee the equipment will operate to the user's satisfaction.

Before installing this equipment, users should ensure that it is permissible to be connected to the facilities of the local telecommunications company. The equipment must also be installed using an acceptable method of connection. The customer should be aware that compliance with the above conditions may not prevent degradation of service in some situations.

Repairs to certified equipment should be made by an authorized Canadian maintenance facility designated by the supplier. Any repairs or alterations made by the user to this equipment, or equipment malfunctions, may give the telecommunications company cause to request the user to disconnect the equipment. User should ensure for their own protection that the electrical ground connections of the power utility, telephone lines and internal metallic water pipe system, if present, are connected together. This precaution may be particularly important in rural areas.

CAUTION: Users should not attempt to make such connections themselves, but should contact the appropriate electric inspection authority, or electrician, as appropriate.

The Load Number (LN) assigned to each terminal device denotes the percentage of the total load to be connected to a telephone loop which is used by the device, to prevent overloading. The termination on a loop may consist of any combination of devices subject only to the requirement that the total of the Load Numbers of all the devices does not exceed 100.

The Load Number of this unit is 2.

FCC COMPLIANCE STATEMENT

CAUTION: Changes or modifications not expressly approved by Digital Security Controls Ltd. could void your authority to use this equipment.

This equipment has been tested and found to comply with the limits for a Class B digital device, pursuant to Part 15 of the FCC Rules. These limits are designed to provide reasonable protection against harmful interference in a residential installation. This equipment generates, uses and can radiate radio frequency energy and, if not installed and used in accordance with the instructions, may cause harmful interference to radio communications. However, there is no guarantee that interference will not occur in a particular installation. If this equipment does cause harmful interference to radio or television reception, which can be determined by turning the equipment off and on, the user is encouraged to try to correct the interference by one or more of the following measures:

- Re-orient the receiving antenna.
- Increase the separation between the equipment and receiver.
- Connect the equipment into an outlet on a circuit different from that to which the receiver is connected.
- Consult the dealer or an experienced radio/television technician for help.

The user may find the following booklet prepared by the FCC useful: "How to Identify and Resolve Radio/Television Interference Problems". This booklet is available from the U.S. Government Printing Office, Washington D.C. 20402, Stock # 004-000-00345-4.

IMPORTANT INFORMATION

This equipment complies with Part 68 of the FCC Rules. On the side of this equipment is a label that contains, among other information, the FCC registration number of this equipment.

NOTIFICATION TO TELEPHONE COMPANY Upon request, the customer shall notify the telephone company of the particular line to which the connection will be made, and provide the FCC registration number and the ringer equivalence of the protective circuit.

FCC Registration Number: F53CAN-30220-AL-E

Ringer Equivalence Number: 0.1B

USOC Jack: RJ-31X

TELEPHONE CONNECTION REQUIREMENTS Except for the telephone company provided ringers, all connections to the telephone network shall be made through standard plugs and telephone company provided jacks, or equivalent, in such a manner as to allow for easy, immediate disconnection of the terminal equipment. Standard jacks shall be so arranged that, if the plug connected thereto is withdrawn, no interference to the operation of the equipment at the customer's premises which remains connected to the telephone network shall occur by reason of such withdrawal.

INCIDENCE OF HARM Should terminal equipment or protective circuitry cause harm to the telephone network, the telephone company shall, where practicable, notify the customer that temporary disconnection of service may be required; however, where prior notice is not practicable, the telephone company may temporarily discontinue service if such action is deemed reasonable in the circumstances. In the case of such temporary discontinuance, the telephone company shall promptly notify the customer and will be given the opportunity to correct the situation.

ADDITIONAL TELEPHONE COMPANY INFORMATION The security control panel must be properly connected to the telephone line with a USOC RJ-31X telephone jack.

The FCC prohibits customer-provided terminal equipment be connected to party lines or to be used in conjunction with coin telephone service. Interconnect rules may vary from state to state.

CHANGES IN TELEPHONE COMPANY EQUIPMENT OR FACILITIES The telephone company may make changes in its communications facilities, equipment, operations or procedures, where such actions are reasonably required and proper in its business. Should any such changes render the customer's terminal equipment incompatible with the telephone company facilities the customer shall be given adequate notice to the effect modifications to maintain uninterrupted service.

RINGER EQUIVALENCE NUMBER (REN) The REN is useful to determine the quantity of devices that you may connect to your telephone line and still have all of those devices ring when your telephone number is called. In most, but not all areas, the sum of the RENs of all devices connected to one line should not exceed five (5.0). To be certain of the number of devices that you may connect to your line, you may want to contact your local telephone company.

EQUIPMENT MAINTENANCE FACILITY If you experience trouble with this telephone equipment, please contact the facility indicated below for information on obtaining service or repairs. The telephone company may ask that you disconnect this equipment from the network until the problem has been corrected or until you are sure that the equipment is not malfunctioning.

Digital Security Controls Ltd. 160 Washburn St., Lockport, NY 14094



© 1997 Digital Security Controls Ltd.
1645 Flint Road, Downsview, Ontario, Canada M3J 2J6
Tel. (416) 665-8460 • Fax (416) 665-7498 • Tech. Line 1-800-387-3630
Printed in Canada 29002069 R1